



Please visit crown.com to find your local Crown dealer.
www.crown.com

CROWN

CB40X-7, CB45X-7, CB50X-7, CB50XC-7

Operation & Maintenance Manual

XSB2470E01NA



XSB2470E01NA
02. 2021

Operation & Maintenance Manual

CB40X-7, CB45X-7, CB50X-7, CB50XC-7
FBB07, FBB08, FBB09, FBB0A



Forklifts



Operation & Maintenance Manual

Forklifts

CB40X-7, CB45X-7, CB50X-7, CB50XC-7

FBB07, FBB08, FBB09, FBB0A

This document is the informational asset of Doosan Corporation. Thus, unauthorized access, revision, distribution and copying of this document are strictly prohibited.



WARNING

A MOVING VEHICLE CAN BE DANGEROUS

You or others around you can be seriously injured or even killed if you are not careful or don't know how to use this truck correctly.

Do not operate this truck unless you are trained and authorized.

Read and obey all warnings and instructions in this Manual* and on the truck.

Make sure the truck is in good working order.

Head, arms, hands or legs outside the operator area can be pinned or crushed when ever the truck is moving. Stay within the operator area and stop completely before getting off.

A dockboard can move or drop while you are on it. Or you could drive off a dock. Falls from docks or dockboards can cause serious injury or even death. Make sure you are safe.

* Additional copies of this Operator Manual and all Truck Labels can be obtained from Crown Equipment Corporation New Bremen, Ohio 45869 U.S.A.

Table of Contents

Information Section

Foreword.....	2
---------------	---

Safety Section

Important Safety Information	4
Safety	5
Warning Signs and Labels	5
General Hazard Information	9
Lift Chains.....	10
Operation Information	11
Maintenance Information	13
Fire or Explosion Prevention	15
Operator Restraint System (If Equipped)	17
Avoiding Lift Truck Tipover.....	22
Safety Rules	24
How to Survive in a Tipover (If Operator Restraint System Equipped)	30

General Section

Declaration of Conformity	31
Specifications.....	32
Noise.....	35
Capacity Chart (Not used in Australia)	36
Capacity Chart - With Side Shifter (Hook on) (Not used in Australia).....	37
Serial Number	38
Operator's Warning and Identification Plate	39

Operation Section

Operator's Station and Monitoring Systems	41
Lift Truck Controls.....	48
Before Operating the Lift Truck.....	53
Lift Truck Operation.....	56
Mono-Ped Control System (Option)	59
Finger Tip (Option)	60
Operating Techniques.....	65
Parking the Lift Truck.....	69
How to deal with failure of Electric Parking Brake (If equipped).....	71
Parking Brake Forced Release Method (If equipped).....	71
Lift Fork Adjustment.....	72
Storage Information.....	73
Transportation Hints.....	74
Towing Information.....	76

Maintenance Section

Jacking Information.....	77
Inspection, Maintenance and Repair of Lift Truck Forks	78
Torque Specifications.....	83
Lubricant Specifications.....	85
Battery Discharge Indicator	87
Battery	88
Cold Storage Applications.....	90
Lubricant Viscosities and Refill Capacities.....	91
Maintenance Intervals.....	92
When Required	93
Every 10 Service Hours or Daily	103
First 50 - 100 Service Hours or a week	109
Every 500 Service Hours or 3 Months.....	110
Every 1000 Service Hours or 6 Months	118
Every 2000 Service Hours or Yearly.....	123

Environment Protection Section

Environment Protection	129
------------------------------	-----

Index Section

Index.....	130
------------	-----

Foreword

Literature Information

This manual should be stored in the operator's compartment in the literature holder or seat back literature storage area.

This manual contains safety, operation, transportation, lubrication and maintenance information.

Some photographs or illustrations in this publication show details or attachments that can be different from your lift truck. Guards and covers might have been removed for illustrative purposes.

Continuing improvement and advancement of product design might have caused changes to your lift truck which are not included in this publication. Read, study and keep this manual with the lift truck.

Whenever a question arises regarding your lift truck, or this publication, please consult your CROWN branch for the latest available information.

Safety

The Safety Section lists basic safety precautions. In addition, this section identifies the text and locations of warning signs and labels used on the lift truck. Read and understand the basic precautions listed in the Safety Section before operating or performing lubrication, maintenance and repair on this lift truck.

Operator Restraint System (If Equipped)

This manual contains safety, operation and maintenance information for the CROWN operator restraint system. Read, study and keep it handy.

WARNING

Your CROWN truck comes equipped with an operator restraint system. Should it become necessary to replace the seat for any reason, it should only be replaced with another CROWN operator restraint system.

Photographs or illustrations guide the operator through correct procedures of checking, operation and maintenance of the CROWN operator restraint system.

SAFE and EFFICIENT OPERATION of a lift truck depends to a great extent on the skill and alertness on the part of the operator. To develop this skill the operator should read and understand the Safe Driving Practices contained in this manual.

Forklift trucks seldom tipover, but in the rare event they do, the operator may be pinned to the ground by the lift truck or the overhead guard. This could result in serious injury or death.

Operator training and safety awareness is an effective way to prevent accidents, but accidents can still happen. The CROWN operator restraint system can minimise injuries. The CROWN operator restraint system keeps the operator substantially within the confines of the operator's compartment and the overhead guard.

This manual contains information necessary for Safe Operation. Before operating a lift truck make sure that the necessary instructions are available and understood.

Operation

The Operation Section is a reference for the new operator and a refresher for the experienced one.

This section includes a discussion of gauges, switches, lift truck controls, attachment controls, transportation and towing information.

Photographs and illustrations guide the operator through correct procedures of checking, starting, operating and stopping the lift truck.

Operating techniques outlined in this publication are basic. Skill and techniques develop as the operator gains knowledge of the lift truck and its capabilities.

Maintenance

The Maintenance Section is a guide to equipment care. The illustrated, step-by-step instructions are grouped by servicing intervals. Items without specific intervals are listed under "When Required" topics. Items in the "Maintenance Intervals" chart are referenced to detailed instructions that follow.

Maintenance Intervals

Use the service hour meter to determine servicing intervals. Calendar intervals shown (daily, weekly, monthly, etc.) can be used instead of service hour meter intervals if they provide more convenient servicing schedules and approximate the indicated service hour meter reading. Recommended service should always be performed at the interval that occurs first.

Under extremely severe, dusty or wet operating conditions, more frequent lubrication than is specified in the "Maintenance Intervals" chart might be necessary.

Perform service on items at multiples of the original requirement. For example, at "Every 500 Service Hours or 3 Months", also service those items listed under "Every 250 Service Hours or Monthly" and "Every 10 Service Hours or Daily".

Environment Management

Note that the Crown internal combustion engine lift trucks are manufactured under ISO 14001 system which is harmonized with ISO 9001.

Periodic ENVIRONMENTAL AUDITS & ENVIRONMENTAL PERFORMANCE EVALUATIONS have been made by internal and external inspection entities. LIFECYCLE ANALYSIS has also been made through out the total product life.

ENVIRONMENT MANAGEMENT SYSTEM includes DESIGN FOR ENVIRONMENT from the initial stage of the design. ENVIRONMENT MANAGEMENT SYSTEM considers environmental laws & regulations, reduction or elimination of resource consumption as well as environmental emission or pollution from industrial activities, energy saving, environment friendly product design(lower noise, vibration, emission, smoke, heavy metal free, ozone depleting substance free, etc.), recycling, material cost reduction, and even environmentally oriented education for the employee.

Important Safety Information

Most accidents involving product operation, maintenance and repair are caused by failure to observe basic safety rules or precautions. An accident can often be avoided by recognizing potentially hazardous situations before an accident occurs. A person must be alert to potential hazards, and use common sense. Persons must also have the necessary training, skills and tools before attempting to perform these functions.

Improper operation, lubrication, maintenance or repair of this product can be dangerous and could result in injury or death.

Do not operate or perform any lubrication, maintenance or repair on this product, until you have read and understood the operation, lubrication, maintenance and repair information.

Safety precautions and warnings are provided in this manual and on the product. If these hazard warnings are not heeded, bodily injury or death could occur to you or other persons.

The hazards are identified by the "Safety Alert Symbol" and followed by a "Signal Word" such as "WARNING" as shown below.



The meaning of this safety alert symbol is as follows:

Attention! Become Alert! Your Safety is Involved.

The message that appears under the warning, explaining the hazard, can be either written or pictorially presented.

Operations that may cause product damage are identified by NOTICE labels on the product and in this publication.

CROWN cannot anticipate every possible circumstance that might involve a potential hazard, and common sense is always required. The warnings in this publication and on the product are therefore not all inclusive. Before any tool, procedure, work method or operating technique not specifically recommended by CROWN is used, you must be sure that it is safe for you and others. You should also ensure that the product will not be damaged or made unsafe by the operation, lubrication, maintenance or repair procedures you choose.

The information, specifications, and illustration in this publication are on the basis of information available at the time it was written. The specifications, torques, pressures, measurements, adjustments, illustrations, and other items can change at any time. These changes can affect the service given to the product. Obtain the complete and most current information before starting any job. CROWN branches have the most current information available.

Safety

The safety rules and regulations in this section are representative of some, but not all rules and regulations that apply to lift trucks. Rules and regulations are paraphrased without representation that they have been reproduced verbatim.

These fork lift trucks are built to meet Australian Standard AS2359 for Powered Industrial Trucks, American National Standard, ANSI B56.1 Safety Standard for Low Lift and High Lift Trucks. Since regulations vary from country to country, operate this lift truck in accordance with local regulations.

CROWN lift trucks are manufactured in accordance with the National Fire Protection Association (NFPA) No. 505 and the American National Standards Institute, Inc. / Industrial Truck Standards Development Foundation (ANSI/ITSDF) B56.1, Safety Standard for Low and High Lift Trucks and, for European models, according to the regulations and standards laid down in EU Machinery Directive 2006/42/EC and EMC directive 2014/30/EU.

The most effective method of reducing the risk of serious injury or death to you or others is for you to know how to properly operate this lift truck, to be alert and to avoid actions or conditions that could cause accidents.

Do not operate a lift truck if it is in need of maintenance, repair or appears to be unsafe in any way. Report all unsafe conditions immediately to your supervisor, then contact your authorised lift truck dealer. Do not attempt any adjustments or repairs unless trained and authorised to do so.

Warning Signs and Labels

There are several specific safety signs on your lift truck. Their exact location and description of the hazard are reviewed in this section. Please take the time to familiarise yourself with these safety signs.

Make sure that you can read all warning and instruction labels. Clean or replace these labels if you cannot read the words or see the pictures. When cleaning the labels use a cloth, water and soap. Do not use solvent, gasoline, etc.

You must replace a label if it is damaged, missing or cannot be read. If a label is on a part that is replaced, make sure a new label is installed on the replaced part. See your branch for new labels.

Training Required to Operate or Service Warning



Located on the left side of the operator's handle at the front view.

WARNING

Improper operation or maintenance could result in injury or death. Do not operate or work on the lift truck unless you are properly trained. Read and understand the Operation and Maintenance Manual. Additional manuals are available from CROWN Lift Truck branches.



This label also provides allowable lift truck capacity information.

General Warnings to Operator

WARNING

Only trained and authorised personnel may operate this machine. For safe operation, read and follow the operation and maintenance Manual furnished with this lift truck and observe the following warnings:

1. Before starting machine. Check all controls and warning devices for proper operation.
 2. Refer to machine identification plate for allowable machine capacity. Do not overload. Operate machines equipped with attachments as partially loaded machines when not handling a load.
 3. Put directional control or shift lever in neutral before "ON-OFF" switch is turned on.
 4. Start, turn and brake smoothly. Slow down for turns, slippery or uneven surfaces. Extremely poor surfaces should be repaired. Avoid running over loose objects or holes in the roadway surfaces. Use extreme caution when turning on inclines.
 5. Travel with load as low as possible and tilted back. If load interferes with visibility, travel with load trailing.
 6. On grade operations travel with load up grade.
 7. Watch out for pedestrians and obstructions. Check overhead clearances.
 8. Do not permit riders on forks or machine at any time.
 9. Do not allow anyone to stand or pass under the elevated portion of any machine.
 10. Be sure operating surface can safely support machine.
 11. Operate machine and attachments only from operator's position.
 12. Do not handle unstable or loosely stacked loads.
 13. Use minimum tilt when picking up or depositing a load.
 14. Use extreme care when handling long, high, or wide loads.
 15. Forks should be completely under load and spread apart as far as load permits.
 16. Machine should be equipped with overhead guard or equivalent protection. Where load requires it, use load backrest extension. Use extreme caution if operating without these devices.
 17. Parking-Lower lifting mechanism to floor. Put directional control or shift lever in neutral. Set parking/secondary brake. Turn "ON - OFF" switch off. Chock wheels if machine is on incline. Disconnect battery when storing electric machines.
 18. Observe safety rules when handling fuel for engine powered machine and when changing batteries for electric machines.
 19. The emergency switch uses in emergency really. When you use often emergency switch by key switch, you can cause fatal mistake to your machine.
 20. If user operates continuously pushing work or both brake pedal and accelerator pedal were depressed at the same time, main electric parts were able to damage.
-

Hand Placement Warning

⚠ WARNING



No hands. Do not place hands in this area. Do not touch, lean on, or reach through the mast or permit others to do so.



Located on the mast.

No Standing On Forks Warning, No Standing Under Forks Warning

⚠ WARNING

Do not stand or ride on the forks. Do not stand or ride on a load or pallet on the forks. Do not stand or walk under the forks.

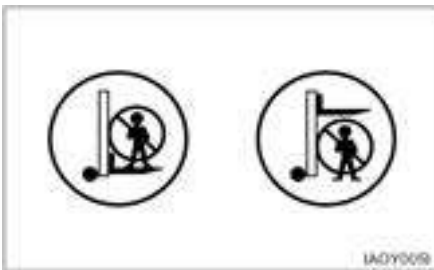

Located on the lift cylinder.

Load Backrest Must Be in Place Warning

⚠ WARNING

Operation without this device in place may be hazardous.



Located on the load backrest.

Overhead Guard Must Be In Place Warning

⚠ WARNING

Operation without this device in place may be hazardous. This guard conforms to A.N.S.I.B56.1 and F.E.M. Section IV. This design has been tested with an impact of appropriate value.



Located on the Overhead Guard.

No Riders Warning



To avoid personal injury, allow no riders. A lift truck is designed for only one operator and no riders.



Located beside the operator's station.

Parking Brake Warning



When leaving machine apply parking brake!
Parking brake is not automatically applied.

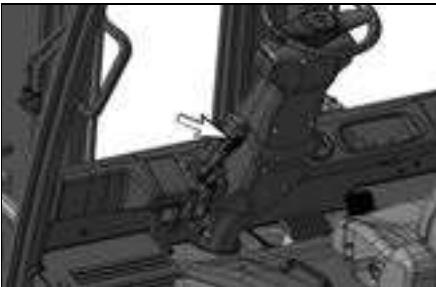

Located on the top left side of the cowl.

Battery Restraint Warning



Located on front of battery cover.



Before operating truck, ensure that hood is securely locked by hood latch, and turn stopper to locking position. Otherwise, a battery may come out of a truck in case of tipover. It could cause the risk of serious injury or death.



Battery Disconnect Before Servicing Warning

AC

WARNING

Disconnect battery from truck and also discharge high voltages from capacitor banks with a 150 ohm, 25 watt Resistor before attempting to service this truck.(B+, B-)



Seat Switch Warning

WARNING

Install any seat to this seat frame. Switch must shut off all power when operator is not seated.



General Hazard Information



Attach a "Do Not Operate" or similar warning tag to start switch or controls before servicing or repairing the lift truck.

Do not start or service the lift truck when a "DO NOT OPERATE" or similar warning tag is attached to the start switch or controls.

Wear a hard hat, protective glasses and other protective equipment as required by job conditions.

Know the width of your attachments so proper clearance can be maintained when operating near fences, boundary obstacles, etc.

Do not wear loose clothing or jewelry that can catch on controls or other parts of the lift truck.

Keep the lift truck, especially the deck and steps, free of foreign material such as debris, oil tools and other items which are not part of the lift truck.

Secure all loose items such as lunch boxes, tools and other items which are not part of the lift truck.

Know the appropriate work-site hand signals and who gives them. Accept signals from one person only.

Always use the overhead guard. The overhead guard is intended to protect the lift truck operator from overhead obstructions and from falling objects.

A truck that is used for handling small objects or uneven loads must be fitted with a load backrest.

If the lift truck must be operated without the overhead guard in place due to low overhead clearance, use extreme care. Make sure there is no possibility of falling objects from any adjacent storage or work area. Make sure the load is stable and fully supported by the carriage and the load backrest extension (if equipped).

Do not raise loads any higher than necessary and never raise a load higher than 1830 mm (72 in) with the overhead guard removed.

Always use load backrest extension when the carriage or attachment does not fully support the load. The load backrest extension is intended to prevent the load or any part of the load from falling backwards into the operator's station.

When operating the lift truck, do not depend only on flashing lights or back-up alarm (if equipped) to warn pedestrians.

Always be aware of pedestrians and do not proceed until the pedestrians are aware of your presence and intended actions and have moved clear of the lift truck and/or load.

Do not drive lift truck up to anyone standing in front of an object.

ObeY all traffic rules and warning signs.

Keep hands, feet and head inside the operator station. Do not hold onto the overhead guard while operating the lift truck. Do not climb on any part of the mast or overhead guard or permit others to do so.

Do not allow unauthorised personnel to ride on the forks or any other part of the lift truck, at any time.

When working in a building or dock, observe floor load limits and overhead clearances.

Inhaling Freon gas through a lit cigarette or other smoking method or inhaling fumes released from a flame contacting Freon can cause bodily harm or death. Do not smoke when servicing air conditioners or wherever Freon gas may be present.

Never put maintenance fluids into glass containers.

Use all cleaning solutions with care.

Do not use steam, solvent, or high pressure to clean electrical components.

Report all needed repairs.

Lift Chains

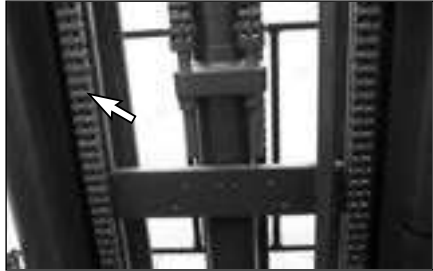

Inspect the part of the chain that is normally operated over the crosshead roller. When the chain bends over the roller, the movement of the parts against each other causes wear.

Inspect to be sure that chain link pins do not extend outside of the bore hole.

If any single link pin is extended beyond its connecting corresponding link, it should be suspected of being broken inside of its bore hole.

Inspect the chain anchor and the anchor links for wear.

Do not change any factory set adjustment values (including engine rpm setting) unless you have both authorization and training. Especially Safety equipment and switches may not be removed or adjusted incorrectly. Repairs, adjustments and maintenances that are not correct can make a dangerous operating condition.

For any checkup, repair, adjustments, maintenance and all other work concerning your forklift truck, please contact your CROWN dealer. We would like to draw your attention to the fact that any secondary damages due to improper handling, insufficient maintenance, wrong repairs or the use of other than original CROWN spare parts waive any liability by CROWN.

Operation Information

Mounting and Dismounting

Mount and dismount the lift truck carefully.

Clean your shoes and wipe your hands before mounting.

Use both hands face the lift truck when mounting and dismounting.

Use the handgrips for mounting and dismounting.

Do not try to climb on or off the lift truck when carrying tools or supplies.

Do not use any controls as handholds when entering or leaving the operator's station.

Never get on or off a moving lift truck. Never jump off the lift truck.

Keep hands and steering wheel free of slippery material.

Before Starting the Lift Truck

Perform a walk-around inspection daily and at the start of each shift. Refer to the topic "Walk-around Inspection" in "Every 10 Service Hours or Daily" section of this manual.

Adjust the seat so that full brake pedal travel can be obtained with the operator's back against the seat back.

Make sure the lift truck is equipped with a lighting system as required by conditions.

Make sure all hydraulic controls are in the HOLD position.

Make sure the direction control lever is in the NEUTRAL position.

Make sure the parking brake is engaged.

Make sure no one is standing and/or working on, underneath or close to the lift truck before operating the lift truck.

Operate the lift truck and controls only from the operator's station.

Make sure the lift truck horn, lights, backup alarm (if equipped) and all other devices are working properly.

Check for proper operation of mast and attachments. Pay particular attention to unusual noises or erratic movement which might indicate a problem.

Make sure service and parking brakes, steering, and directional controls are operational.

Make sure all personnel are clear of lift truck and travel path.

Refer to the topic "Lift Truck Operation" in the "Operation Section" of this manual for specific starting instructions.

Starting the Lift Truck



Do not start the engine or move any of the controls if there is a "DO NOT OPERATE" or similar warning tag attached to the start switch or controls.

Before Operating the Lift Truck

Test brakes, steering controls, horn and other devices for proper operation. Report any faulty performance. Do not operate lift truck until repaired.

Learn how your lift truck operates. Know its safety devices. Know how the attachments work. Before moving the lift truck, look around. Start, turn and brake smoothly.

An operator must constantly observe his lift truck for proper operation.

Operating the Lift Truck

Always keep the lift truck under control.

Obey all traffic rules and warning signs.

Never leave the lift truck with the engine operating, or with the parking brake disengaged.

Operate the engine only in a well ventilated area.

Lower the mast, with or without load, before turning or traveling. Tip over could result. Watch out for overhead obstructions.

Always observe floor load limits and overhead clearance.

Start, turn, and brake smoothly. Slow down for turns, grades, slippery or uneven surfaces.

Use special care when operating on grades. Do not angle across or turn on grades. Do not use a lift truck on slippery grades. Travel with forks downgrade when unloaded. Travel with load upgrade.

Do not overload, or handle offset, unstable, or loosely stacked loads. Refer to load capacity plate on the lift truck. Use extreme caution when handling suspended, long, high or wide load.

Tilt an elevated load forward only when directly over unloading area and with load as low as possible.

Do not stunt ride or indulge in horseplay.

Always look and keep a clear view of the path of travel.

Travel in reverse if load or attachment obstructs visibility. Use extreme caution if visibility is obstructed.

Stay in designated travel path, clear of dock edges, ditches, other drop-offs and surfaces which cannot safely support the lift truck.

Slow down and use extra care through doorways, intersections and other location where visibility is reduced.

Slow down for cross aisles, turns, ramps, dips, uneven or slippery surfaces and in congested areas and avoid pedestrians, other vehicles, obstruction, pot holes and other hazards or objects in the path of travel.

Always use overhead guards except where operation conditions do not permit. Do not operate lift truck in high stacking areas without overhead guards.

When stacking, watch for falling objects. Use load backrest extension and overhead guard.

Refer to the topic "Operation Techniques" in the "Operation Section" of this manual.

Loading or Unloading Trucks/Trailers

Do not operate lift trucks on trucks or trailers which are not designed or intended for that purpose. Be certain truck or trailer brakes are applied and wheel chocks in place (or be certain unit is locked to the loading dock) before entering onto trucks or trailers.

If trailer is not coupled to tractor, make sure the trailer landing gear is properly secured in place. On some trailers, extra supports may be needed to prevent upending or corner dipping.

Be certain dock plates are in good condition and properly placed and secured. Do not exceed the rated capacity of dock boards or bridge plates.

Lift Truck Parking

When leaving the operator station, park the lift truck in authorised areas only. Do not block traffic.

- Park the lift truck level, with the forks lowered and the mast tilted forward until the fork tips touch the floor.
- Move the direction control lever to NEUTRAL.
- Engage the parking brake.
- Turn the key switch off and remove the key.
- Turn the disconnect switch to OFF (if equipped).
- Block the drive wheels when parking on an incline.

Maintenance Information

Perform all maintenance unless otherwise specified as follows :

- Park the lift truck in authorised areas only.
- Park the lift truck level, with the forks lowered and the mast tilted forward until the fork tips touch the floor.
- Place the control lever in neutral.
- Engage the parking brake.
- Remove the start switch key and turn the disconnect switch OFF (if equipped).
- Block the drive wheels when parking on an incline.

Pressure Air

Pressure air can cause personal injury. When using pressure air for cleaning, wear a protective face shield, protective clothing and protective shoes.

The maximum air pressure must be below 205 kPa (30 psi) for cleaning purposes.

Fluid Penetration

Always use a board or cardboard when checking for a leak. Escaping fluid under pressure, even a pinhole size leak, can penetrate body tissue, causing serious injury, and possible death. If fluid is injected into your skin, it must be treated by a doctor familiar with this type of injury immediately.

Crushing or Cutting Prevention

Support equipment and attachments properly when working beneath them. Do not depend on hydraulic cylinders to hold it up. Any attachment can fall if a control is moved, or if a hydraulic line breaks.

Never attempt adjustments while the lift truck is moving or the engine is running unless otherwise specified.

Where there are attachment linkages, the clearance in the linkage area will increase or decrease with movement of the attachment.

Stay clear of all rotating and moving parts.

Keep objects away from moving fan blades. They will throw or cut any object or tool that falls or is pushed into them.

Do not use a kinked or frayed wire rope cable. Wear gloves when handling the wire rope cable.

Retainer pins, when struck with force, can fly out and injure nearby persons. Make sure the area is clear of people when driving retainer pins.

Wear protective glasses when striking a retainer pin to avoid injury to your eyes.

Chips or other debris can fly off objects when struck.

Make sure no one can be injured by flying debris before striking any object.

Falling Objects Protective Structure (FOPS)

This is an attached guard located above the operator's compartment and secured to the lift truck.

To avoid possible weakening of the Falling Objects Protective Structure (FOPS), consult a CROWN branch before altering, by adding weight to, welding on, or cutting or drilling holes into the structure.

The overhead guard is not intended to protect against every possible impact. The overhead guard may not protect against some objects penetrating into the operator's station from the sides or ends of the lift truck.

The lift truck is equipped with an overhead guard and FOPS as standard. If there is a possibility of overhead objects falling through the guard, the guard must be equipped with smaller holes or a Plexiglas cover.

Any altering done that is not specifically authorised by CROWN invalidates CROWN's FOPS certification. The protection offered by this FOPS will be impaired if it has been subjected to structural damage. Structural damage can be caused by an overturn accident, by falling objects, etc.

Do not mount any item such as fire extinguishers, first aid kits and lights by welding brackets to or drilling holes in any FOPS structure. See your CROWN branch for mounting guidelines.

Burn Prevention

Oils

Hot oil and components can cause personal injury. Do not allow hot oil or components to contact the skin.

At operation temperature, the hydraulic tank is hot and can be under pressure.

Remove the hydraulic tank filter cap only after the engine has been stopped and the filter cap is cool enough to remove with your bare hand.

Remove the hydraulic tank filter cap slowly to relieve pressure.

Relieve all pressure in air, oil fuel or cooling systems before any lines, fittings or related items are disconnected or removed.

Batteries

Only trained and designated personnel should inspect, recharge or exchange batteries.

Always wear protective glasses when working with batteries.

Service, exchange and handle batteries only in authorised areas when proper safety and ventilation facilities are provided.

Do not smoke, or expose battery to sparks or flame when checking, charging or servicing battery. Keep chains and metallic tools away from top of battery.

Batteries give off flammable fumes which can explode.

Highly explosive gases are especially hazardous toward the end of the charging period as the battery approaches a full charge condition.

Electrolyte is an acid and can cause personal injury if it contacts skin or eyes.

Service batteries in accordance with battery manufacture instructions.

Refer to the topic "Batteries" in the "Maintenance Section" of this manual.

Fire or Explosion Prevention

All fuels, most lubricants and some coolant mixtures are flammable.

Do not smoke in areas where batteries are charged, or where flammable materials are stored.

Clean and tighten all electrical connections. Check daily for loose or frayed electrical wires. Have all loose or frayed electrical wires tightened, repaired or replaced before operating the lift truck.

Keep all fuels and lubricants stored in properly marked containers and away from all unauthorised persons.

Store all oily rags or other flammable material in a protective container, in a safe place.

Do not weld or flame cut on pipes or tubes that contain flammable fluids. Clean them thoroughly with nonflammable solvent before welding or flame cutting on them.

Remove all flammable materials such as fuel, oil and other debris before they accumulate on the lift truck.

Do not expose the lift truck to flames, burning brush, etc., if at all possible.

Do not operate in areas where explosive gases exist or are suspected.

Fire Extinguisher

Have a fire extinguisher-type BC and 1.5KG minimum capacity-on rear overhead guard leg with latch and know how to use it. Inspect and have it serviced as recommended on its instruction plate.

Lines, Tubes and Hoses

Do not bend or strike high pressure lines. Do not install bent or damaged lines, tubes or hoses.

Repair any loose or damaged fuel and oil lines, tubes and hoses. Leaks can cause fires. Contact your CROWN branch for repair or replacement.

Check lines, tubes and hoses carefully. Do not use your bare hand to check for leaks. Use a board or cardboard to check for leaks. See Fluid Penetration in the Safety Section for more details. Tighten all connections to the recommended torque. Replace if any of the following conditions are found.

- End fittings damaged or leaking.
- Outer covering chafed or cut and wire reinforcing exposed.
- Outer covering ballooning locally.
- Evidence of kinking or crushing of the flexible part of hose.
- Armoring embedded in the outer cover.
- End fittings displaced.

Make sure that all clamps, guards and heat shields are installed correctly to prevent vibration, rubbing against other parts, and excessive heat during operation.

Tyre Information

Servicing, changing tyres and rims can be dangerous and should be done only by trained personnel using proper tools and procedures. If correct procedures are not followed while servicing tyres and rims, the assemblies could burst with explosive force and cause serious personal injury or death. Follow carefully the specific information provided by your tyre or rim servicing personnel or dealer.

CROWN forklift is equipped with wheels from different manufacturers.

Please re-use the original parts of the existing wheel, if there is no deformation of the wheel after checked. Mixing up new and old parts may cause incomplete assembly that might lead to unexpected dismantlement of parts and accident.

Operator Restraint System (If Equipped)

Warning Signs and Labels

Your CROWN lift truck has the following tipover warning decals.

Make sure that you can read all safety signs. Clean or replace these if you cannot read the words or see the pictures. When cleaning the labels use a cloth, water and soap. Do not use solvent, gasoline, etc. You must replace a label if it is damaged, missing or cannot be read. If a label is on a part that is replaced, make sure a new label is installed on the replaced part. See your CROWN Lift Truck branch for new labels.

The most effective method of preventing serious injury or death to yourself or others is to familiarise yourself with the proper operation of the lift truck, to be alert, and to avoid actions or conditions which can result in an accident.



Tipover can occur if the truck is improperly operated. In the event of tipover, injury or death could result.

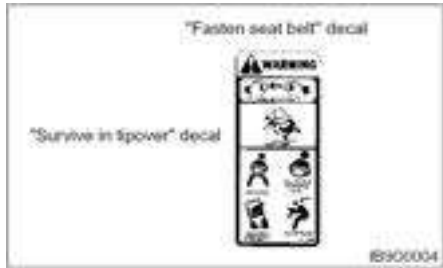

The "Survive in tipover" warning is located on the overhead guard. It shows the proper use of the operator restraint system.

Seat Adjustment



Move the lever, slide the seat to the desired position,

Safety Section

and release the lever.

Adjust the seat before operating the lift truck. After adjusting, set the seat to make sure it is properly locked. Do not adjust the seat while the truck is in motion.

WARNING

Do not place your hand or fingers under the seat. Injury may occur as the seat moves up and down.

If Optional Suspension Seat Equipped

Forward and Backward Adjustment

The seat can be adjusted by pushing the lever on the right side of seat.



Adjust the seat before operating the lift truck. After adjusting, set the seat to make sure it is properly locked. Do not adjust the seat while the truck is in motion.

Weight adjustment

Pull the weight adjustment lever upwards and move right or left side.

Adjust to driver's weight in 7 steps (50 ~ 110 kg)

NOTICE

Do not place your hand or fingers under the seat. Injury may occur as the seat moves up and down.



Backrest Inclusion

The backrest angle can be adjusted by using the lever on the left side of seat.

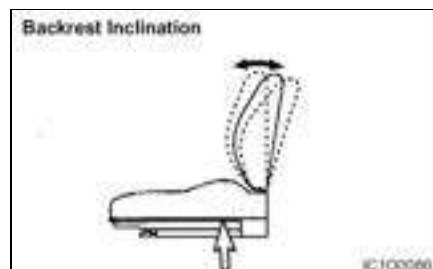

Seat Belt

The Operator Restraint System, Prevents the operator from jumping from the operator's compartment in the event of forward or side tipover. The system is designed to keep the operator on the seat and in the operator's compartment in the event of tipover.

Inspection

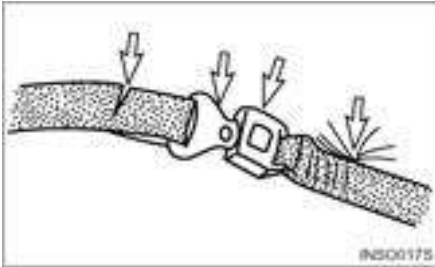

1. If the seat belt is torn, if pulling motion is interrupted during extension of the belt, or if the belt cannot be inserted into the buckle properly, replace the seat belt assembly.



2. Belt Maintenance – Every 500 service hours. Check that the belt fastening works properly and that winding device is free from run lock when jerked. Check that the belt is suitably fastened to the seat. Check that the seat is correctly secured to the hood and the chassis. On visual inspection, fastenings must be intact, otherwise, contact the safety manager.

⚠ WARNING

Your CROWN truck comes equipped with a CROWN operator restraint system. Should it become necessary to replace the seat for any reason, it should only be replaced with another CROWN operator restraint system.



3. In the event of tipover, the seat and restraint system should be inspected for damage and replaced, if necessary.

NOTE: Operator restraints shall be examined at the regular truck service intervals. It is recommended that they be replaced if any of the following conditions are found:

- Cut or frayed strap
- Worn or damaged hardware including anchor points
- Buckle or retractor malfunction
- Loose stitching

⚠ WARNING

The seat belt may cause the operator to bend at the waist. If you are pregnant or have suffered from some abdominal disease, consult a doctor before you use the seat belt.

Fasten the Seat Belt

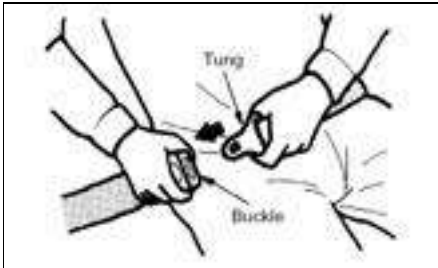

1. Grip the plate (connector) of the belt and pull the belt from the retractor. Then insert the plate into the slot of the buckle until a snap is heard. Pull on the belt to confirm it is latched.
2. Make sure the belt is not twisted.

WARNING

If you fasten the belt across your abdomen, the belt may injure your abdomen in an accident.

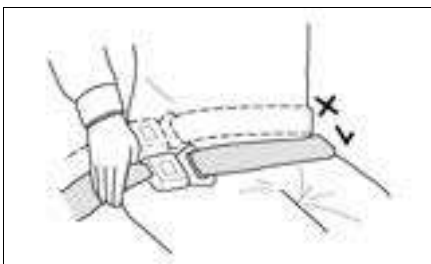

3. Be sure to fasten the belt across your hips, not across your abdomen.

NOTE: The belt is designed to automatically adjust to your size and movement. A quick pull on the belt will confirm that the automatic adjuster will hold the belt position in the event of an accident.

Release the Seat Belt

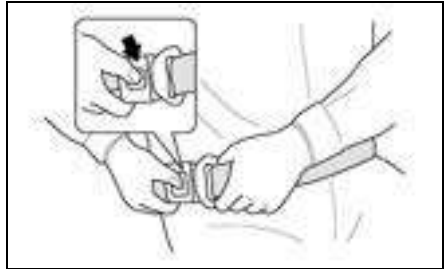

Push the button of the buckle to release the belt. The belt will automatically retract when released. Hold the plate of the belt and allow the belt to slowly retract.

Avoiding Lift Truck Tipover

Lift Truck Stability

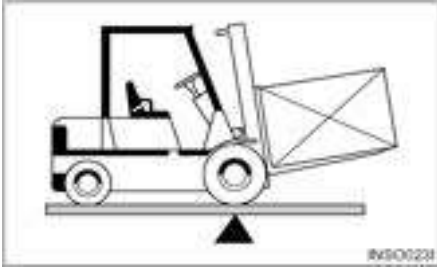

Counterbalanced lift truck design is based on the balance of two weights on opposite sides of a fulcrum (the front axle). The load on the forks must be balanced by the weight of the lift truck.

The location of the centre of gravity of both the truck and the load is also a factor. This basic principle is used for picking up a load. The ability of the lift truck to handle a load is discussed in terms of centre of gravity and both forward and sideways stability.

Centre of Gravity (CG)

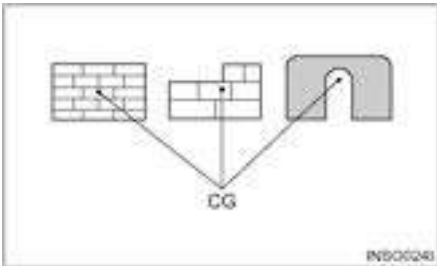

The point within an object, at which the whole weight of the object may be regarded as being concentrated, is called the centre of gravity or CG. If the object is uniform, its geometric centre will coincide with its CG. If it is not uniform, the CG could be at a point outside of the object. When the lift truck picks up a load, the truck and load have a new combined CG.

Stability and Centre of Gravity

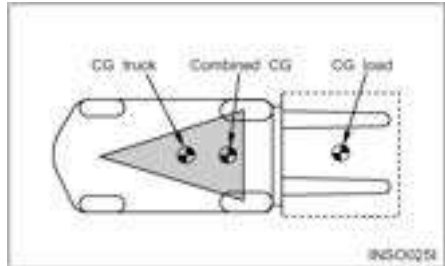

The stability of the lift truck is determined by the location of its CG; or, if the truck is loaded, the combined CG of the truck and load. The lift truck has moving parts and, therefore, has a CG that moves. The CG moves forward or backward as the mast is tilted forward or backward. The CG moves up or down as the mast moves up or down. The CG and, therefore, the stability of the loaded lift truck, are affected by a number of factors such as:

- the size, weight, shape and position of the load
- the height to which the load is lifted
- the amount of forward or backward tilt
- tyre pressure
- dynamic forces created when the lift truck is accelerated, braked or turned
- condition and grade of surfaces on which the lift truck is operated

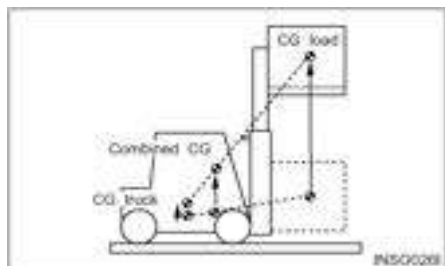

These same factors are also important for unloaded lift trucks. They tip over sideways easier than a loaded lift truck carrying its load in the lowered position.

Lift Truck Stability Base

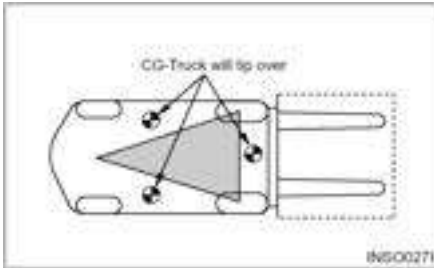

For the lift truck to be stable (not tip over forward or to the side), the CG must stay within the area of the lift truck stability base – a triangular area between the front wheels and the pivot of the steer wheels. If the CG moves forward of the front axle, the lift truck will tip forward. If the CG moves outside of the line on either side of the stability base, the lift truck will tip to the side.

⚠ WARNING

Dynamic forces (braking, acceleration, turning) also affect stability and can produce tipover even when the CG is within the stability triangle.

Capacity Load (Weight and Load Centre)

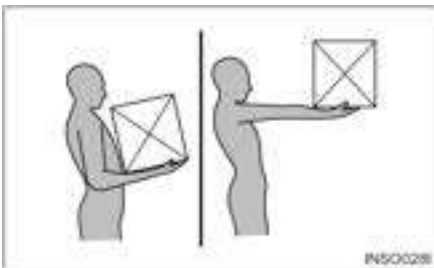

The capacity load of the lift truck is shown on the capacity/nameplate riveted to the truck. It is determined by the weight and load centre. The load centre is determined by the location of the CG of the load.

The load centre shown on the nameplate is the horizontal distance from the front face of the forks, or the load face of an attachment, to the CG of the load. The location of the CG in the vertical direction is the same as the horizontal dimension.

Remember that, unless otherwise indicated, the capacity load shown on the nameplate is for a standard lift truck with standard backrest, forks and mast, and having no special-purpose attachment. In addition, the capacity load assumes that the load centre is no further from the top of the forks than it is from the face of the backrest. If these conditions do not exist, the operator may have to reduce the safe operating load because the truck stability may be reduced. The lift truck should not be operated if its capacity/nameplate does not indicate capacity load.

NOTE: If the load is not uniform, the heaviest portion should be placed closer to the backrest and centred on the forks.

NOTICE

1. Capacity/Nameplates originally attached to forklifts sold by CROWN shall not be removed, altered or replaced without CROWN's approval.
2. CROWN assumes no responsibility for lift trucks placed in service without a valid CROWN Nameplate.
3. If necessary to change your specification, contact your CROWN lift truck dealer.

Safety Rules



Only properly trained and authorised personnel should operate forklift trucks. Wear a hard hat and safety shoes when operating a lift truck. Do not wear loose clothing.



Inspect and check the condition of your forklift truck using the operator's check list before starting work. Immediately report to your supervisor any obvious defects or required repairs.



Do not operate your truck in unauthorised areas.
Know your forklift truck and think safety.
Do not compromise safety.
Follow all safety rules and read all warning signs.



Do not operate a lift truck unless you are in the operator's seat. Keep hands and feet inside the operator's compartment. Do not put any part of the body outside of the operator's compartment. Never put any part of body into the mast structure or between the mast and the truck.



Do not start, stop, turn or change direction suddenly or at high speed. Sudden movement can cause the lift truck to tip over. Slow the speed of your truck and use the horn near corners, exits, entrances, and near people.

In case of a truck with the steering knob, Do not operate the steering knob suddenly, to prevent accident caused by quick turning.



Never operate a lift truck with wet hands or shoes. Never hold any controls with grease on your hands. Your hands or feet will slide off of the controls and cause an accident.



Do not raise anyone on the forks of your lift.
Do not let other people ride on the truck. Lift trucks are designed to carry loads, not people.



Do not overload. Always handle loads within the rated capacity shown on the capacity plate.
Do not add extra counterweight to the truck. An overload can cause the truck to roll over and cause injury to personnel and damage to the lift truck.



Do not operate your truck without the load backrest extension and overhead guard. Keep the load against the backrest with the mast tilted backward.



Do not drive on soft ground.
Observe all signs, especially those on maximum permitted floor loadings, elevator capacities and clearance heights.



Do not lift or move loads that are not safe. Do not pick up an off centre load. Such a load increases the possibility of a tipover to the side. Make sure loads are correctly stacked and positioned across both forks. Always use the proper size pallet. Position the forks as wide as possible under the load. Position loads evenly on the forks for proper balance. Do not lift a load with one fork.



Do not drive on slippery surfaces.
Sand, gravel, ice or mud can cause a tipover.
If unavoidable, slow down.



Do not permit anyone to stand or walk under the load or lifting mechanism. The load can fall and cause injury or death to anyone standing below.



Do not elevate the load with the mast tilted forward.
Do not tilt the elevated loads forwards.
This will cause the lift truck to tip over forward.



Look out for overhead obstructions when raising or stacking loads. Do not travel with a raised load. Do not travel with the mast raised. The lift truck can roll over and cause injury or death to you or other personnel.



Do not jump off if your truck starts to tip over.
Stay in your seat to survive.



Do not move loose loads that are higher than the load backrest.

Be alert for falling loads when stacking.

Travel with the load tilted back and the forks as low as possible.

This will increase stability to the truck and load and permit better visibility for you.



Go up ramps in forward direction and down ramps in reverse direction when moving loads.

Never elevate a load with the forklift truck on an incline.

Go straight off and straight down. Use an assistant when going up or down a ramp with a bulky load.

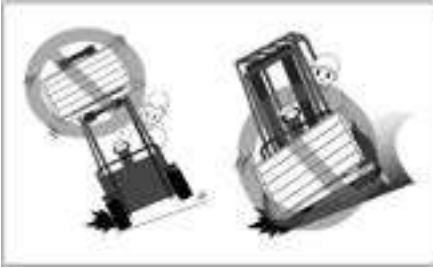

Do not stack or turn on ramps.

Do not attempt to pick-up or deposit a load unless the lift truck is level. Do not turn on or drive across an incline.



Do not drive in forward direction when loads restrict your visibility. Operate your lift truck in reverse to improve visibility except when moving up a ramp.



Do not go over rough terrain. If unavoidable, slow down.

Cross railroad tracks slowly and diagonally whenever possible. A railroad crossing can give a loaded forklift truck a real jolt. For smoother crossing, cross the railroad diagonally so one wheel crosses at a time.

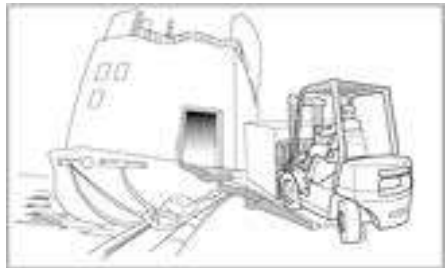

Be careful when operating a lift truck near the edge of a loading dock or ramp. Maintain a safe distance from the edge of docks, ramps and platforms. Always watch tail swing.

The truck can fall over the edge and cause injury or death.

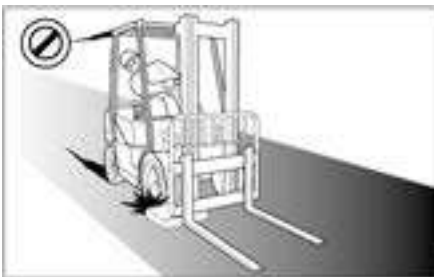

Avoid running over loose objects. Look in the direction of travel. Look out for other persons or obstructions in your path of travel. An operator must be in full control of his lift truck at all times.



Do not operate on bridge plates unless they can support the weight of the truck and load. Make sure that they are correctly positioned. Put blocks on the vehicle you enter to keep it from moving.



Do not operate your truck close to another truck. Always keep a safe distance from other trucks and make sure there is enough distance to stop safely. Never overtake other vehicles.



Park your lift truck in authorised areas only. Fully lower the forks to the floor, put direction lever in NEUTRAL position, engage the parking brake, and turn the key to the OFF position. Remove the key and put blocks behind the wheels to prevent the truck from rolling. Shut off your forklift truck when leaving it unattended.

Check the condition of your forklift truck after the day's work.



Do not use your lift truck to push or tow another truck.

Do not let another push or tow your truck.

If a truck will not move, call a service technician.

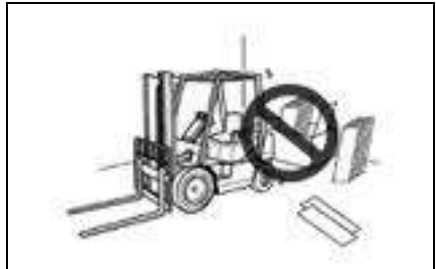

Do not operate forklifts near flammable or combustible materials.

To avoid the discoloration, deformation or combustion of materials (such as lumber, veneer board, paper products and other similar items), always park at least 30 cm (12 inches) away from them.



Forklift trucks are not cars. They often have small tyres, no suspension, and are very heavy.

The forklift's centre of gravity will also change when carrying loads.

Avoid uneven bumps, pot holes and other hazards whenever possible.



There are many special attachments available to replace the forks on a lift truck.

All carry safety implications and special training in their operation is highly recommended.



Carrying a load suspended on a chain or a cable may unbalance a truck.

Take extra care around pedestrians with a suspended load as it may sway or even strike them.

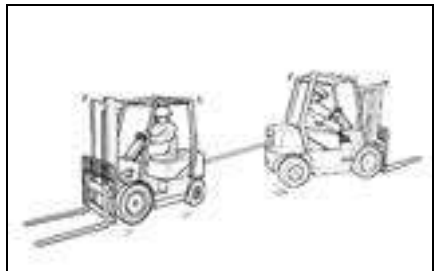

The counterweight draw bar should not be used for towing the forklift or for towing another forklift.

Towing is only advised in emergencies, by trained operators and at low speed, no faster than 2 km/h, to a convenient location for repair.



An unloaded forklift may be easier to tip over than a loaded truck.

When traveling without a load, the risk of lateral overturn is greater.

How to Survive in a Tipover (If Operator Restraint System Equipped)

⚠ WARNING

In the event of a tipover, the risk of serious injury or death will be reduced if the operator is using the operator restraint system and follows the instructions provided.



Brace your feet and keep them within the operator's compartment.

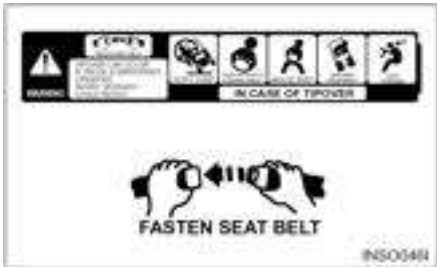

Always use operator restraint system.



Lean away from the direction of fall.



Don't jump.



Lean forward



Hold on tight.

Declaration of Conformity

We,

Manufacturer

Doosan Corporation Industrial Vehicle BG.
468, Injung-ro, Dong-gu, Incheon, Korea 22503

Authorised Representative and Compiler of Technical File According to 2006/42/EC

Doosan Industrial Vehicle Europe N.V., Mr. Chankyo Chung,
Europark-Noord 36 A, 9100 Sint-Niklaas, Belgium

herewith declare

that the following equipment conforms with the appropriate requirements of the Directives 2006/42/EC (Machinery Directive), and 2014/30/EU (EMC Directive) based on its design and type, as brought into circulation by us.

Description of the equipment:

Type : *Lift Truck, Battery Powered Driven, Counterbalanced*

Function : *Lifting and Moving materials*

Family : *CB40X/ 45X /50XC/ 50X-7 Series (with 80 Voltage)*

Model/Commercial Name :

Serial Name :

Applicable EC Directives : 2006/42/EC, 2014/30/EU

Applicable harmonized standard : EN 16307-1;2013+A1;2015, EN ISO 3691-1;2015
EN 1175-1:1998+A1:2010, EN 12895:2015+A1:2019

Specifications

		Model group		
Characteristics	1.1	Manufacturer		
	1.2	Manufacturer's type designation		
	1.3	Drive : electric (battery or mains) , diesel, petrol ,fuel gas, manual		
	1.4	Operator type : hand, pedestrian, standing, seated, order-picker		
	1.5	Load capacity/rated load	Q	lb(kg)
	1.6	Load centre distance	c	in(mm)
	1.8	Load distance, centre of drive axle to fork	x	in(mm)
	1.9	Wheelbase	y	in(mm)
Weights	2.1	Service weight (with min. weight of battery)		lb(kg)
	2.2	Axle loading, loaded front/rear		lb(kg)
	2.3	Axle loading, unloaded front/rear		lb(kg)
Wheels & Tyres	3.1	Tyres: pneumatic (P), superelastic (SE), cushion (C)		
	3.2	Tyre size, front		
	3.3	Tyre size, rear		
	3.5	Wheels, number front/rear (x=driven wheels)		
	3.6	Tread width, front	b10	in(mm)
	3.7	Tread width, rear	b11	in(mm)
	4.1	Tilt of mast/fork carriage forward (α)/backward(β)	α / β	deg
Basic dimensions	4.2	Height, mast lowered	h1	in(mm)
	4.3	Free lift	h2	in(mm)
	4.4	Lift (with STD 2-stage mast)	h3	in(mm)
		Lift height	h23	in(mm)
	4.5	Height, mast extended	h4	in(mm)
	4.7	Height to top of overhead guard	h6	in(mm)
	4.8	Seat height/stand height	h7	in(mm)
	4.12	Towing coupling height	h10	in(mm)
	4.19	Overall length	l1	in(mm)
	4.20	Length to face of forks	l2	in(mm)
	4.21	Overall width	b1	in(mm)
	4.22	Fork dimensions	s / e / l	in(mm)
	4.23	Fork carriage ISO 2328. Class/type A, B		
	4.24	Fork carriage width	b3	in(mm)
	4.24a	Fork Spacing (min/max)		in(mm)
	4.31	Ground clearance, with load, below mast	m1	in(mm)
	4.32	Ground clearance, center of wheelbase	m2	in(mm)
4.34.1	Aisle width for pallets 1000 x 1200 crossways	Ast	in(mm)	
4.34.1	Aisle width for pallets 800 x 1200 lengthways	Ast	in(mm)	
4.35	Turning radius	Wa	in(mm)	
4.36	Internal turning radius	b13	in(mm)	
Performance	5.1	Travel speed, loaded / unloaded		mph(km/h)
	5.2	Lift speed, loaded / unloaded		fpm(mm/s)
	5.3	Lowering speed, loaded / unloaded		fpm(mm/s)
	5.6	Maximum drawbar pull, loaded / unloaded, 5 minute rating		lbf(N)
	5.8	Maximum gradeability, loaded / unloaded, 5 minute rating		%
	5.10	Service brake Parking brake		
Electric	6.1	Drive motor rating S2 60 minute		HP(kW)
	6.2	Lifting motor rating at S3 15%		HP(kW)
	6.3	Battery as per DIN 43531 /35/36 A, B, C, no		
	6.4	Battery voltage/nominal capacity K5		V/Ah
	6.5	Battery weight (min) Battery dimensions L/W/H		lb(kg) in(mm)
Others	8.1	Type of drive control unit		
	8.2	Working press for attachments	System Attachment	psi(bar)
	8.4	Sound level at the driver's ear according to EN 12 053		dB (A)

CROWN	CROWN	CROWN	CROWN	1.1
CB40X	CB45X	CB50XC	CB50X	1.2
Electric	Electric	Electric	Electric	1.3
Driver seated	Driver seated	Driver Seated	Driver Seated	1.4
8,000 (4,000)	9,000 (4,500)	10,000 (4,990)	10,000 (5,000)	1.5
24 (500)	24 (500)	24 (500)	24 (500)	1.6
22.5 (572)	22.5 (572)	22.5 (572)	22.5 (572)	1.8
78.7(2,000)	78.7 (2,000)	78.7 (2,000)	78.7(2,000)	1.9
15,459(7,012)	16,373 (7,427)	17,050 (7,734)	17,114(7,763)	2.1
21,768 / 2,509 (9,874) / (1,138)	23,384 / 2,910 (10,607) / (1,320)	25,165 / 2,905 (11,415) / (1,318)	25,242 / 2,892 (11,450) / (1,312)	2.2
8,223 / 7,235 (3,730) / (3,282)	8,146 / 8,228 (3,695) / (3,732)	8,234 / 8,814 (3735) / (3,998)	8,311 / 8,800 (3,770) / (3,992)	2.3
SE	SE	SE	SE	3.1
250 – 15	28 x 12.5 – 15	28 x 12.5 – 15	28 x 12.5 – 15	3.2
7.00 - 12	7.00 - 12	7.00 - 12	7.00 - 12	3.3
2/2	2/2	2/2	2/2	3.5
46.0 (1,168)	45.7 (1,160)	45.7 (1,160)	45.7 (1,160)	3.6
43.7 (1,111)	43.7 (1,111)	43.7 (1,111)	43.7 (1,111)	3.7
6 / 9	6 / 9	6 / 9	6 / 9	4.1
91.7 (2,330)	92.1 (2,340)	92.1 (2,340)	92.1 (2,340)	4.2
6.3 (160)	6.3 (160)	6.3 (160)	6.3 (160)	4.3
127.9 (3,250)	127.9 (3,250)	127.9 (3,250)	127.9 (3,250)	4.4
129.9 (3,300)	129.9 (3,300)	129.9 (3,300)	129.9 (3,300)	4.5
179.7 (4,565)	179.7 (4,565)	179.7 (4,565)	185.6 (4,715)	4.5
92.3 (2,345)	92.5 (2,350)	92.5 (2,350)	92.5 (2,350)	4.7
51.0 (1,297)	51.3 (1,303)	51.3 (1,303)	51.3 (1,303)	4.8
16.3 (415)	16.3 (415)	16.3 (415)	16.3 (415)	4.12
157.7 (4,007)	157.7 (4,007)	158.9 (4,037)	158.9 (4,037)	4.19
116.4 (2,957)	116.4 (2,957)	117.6 (2,987)	116.4 (2,957)	4.20
57.8 (1,470)	57.8 (1,470)	57.8 (1,470)	57.8 (1,470)	4.21
1.9/ 5.9 / 41.3 (50 / 150 / 1,050)	1.9/ 5.9 / 41.3 (50 / 150 / 1,050)	1.9/ 5.9 / 41.3 (50 / 150 / 1,050)	1.9/ 5.9 / 41.3 (50 / 150 / 1,050)	4.22
III A	III A	III A	IV A	4.23
49.2 (1,250)	49.2 (1,250)	49.2 (1,250)	52.3 (1,330)	4.24
12.2 x 46.5 (310 x 1,182)	12.2 x 46.5 (310 x 1,182)	12.2 x 46.5 (310 x 1,182)	13.4 x 50.8 (340 x 1,290)	4.24a
4.7 (120)	5.1 (130)	5.1 (130)	5.1 (130)	4.31
6.2 (160)	6.2 (160)	6.2 (160)	6.2 (160)	4.32
173.8 (4,416)	173.8 (4,417)	174.8 (4,442)	174.8 (4,442)	4.34.1
183.2 (4,655)	183.3 (4,656)	184.2 (4,681)	184.2 (4,681)	4.34.1
103.1 (2,620)	103.1 (2,620)	104.1 (2,645)	104.1 (2,645)	4.35
34.5 (877)	34.6 (879)	34.6 (879)	34.6 (879)	4.36
9.3 / 9.9 (15 / 16)	9.3 / 9.9 (15 / 16)	9.3 / 9.9 (15 / 16)	9.3 / 9.9 (15 / 16)	5.1
68.9 / 92.5 (350 / 470)	65.0 / 92.5 (330 / 470)	65.0 / 92.5 (330 / 470)	61.0 / 92.5 (310 / 470)	5.2
94.5 / 88.6 (480 / 450)	94.5 / 88.6 (480 / 450)	94.5 / 88.6 (480 / 450)	94.5 / 88.6 (480 / 450)	5.3
4,185 / 4,185 (18,620 / 18,620)	4,185 / 4,185 (18,620 / 18,620)	4,185 / 4,185 (18,620 / 18,620)	4,185 / 4,185 (18,620 / 18,620)	5.6
17 / 27	16 / 26	15 / 25	15 / 25	5.8
FOOT / HYD	FOOT / HYD	FOOT / HYD	FOOT / HYD	5.10
HAND / MECH (EPB, OPTIONAL)	HAND / MECH (EPB, OPTIONAL)	HAND / MECH (EPB, OPTIONAL)	HAND / MECH (EPB, OPTIONAL)	
13.4 X 2(10 X 2)	13.4 X 2(10 X 2)	13.4 X 2(10 X 2)	13.4 X 2(10 X 2)	6.1
37.5 (28)	37.5 (28)	37.5 (28)	37.5 (28)	6.2
DIN43536A	DIN43536A	DIN43536A	DIN43536A	6.3
80 / 720	80 / 720	80 / 720	80 / 720	6.4
4,761.9 (2,160)	4,761.9 (2,160)	4,761.9 (2,160)	4,761.9 (2,160)	6.5
39.3 / 40.5 / 30.9 (999 / 1,028 / 784)	39.3 / 40.5 / 30.9 (999 / 1,028 / 784)	39.3 / 40.5 / 30.9 (999 / 1,028 / 784)	39.3 / 40.5 / 30.9 (999 / 1,028 / 784)	8.1
Inverter AC	Inverter AC	Inverter AC	Inverter AC	
2,755.0 (190)	3,045.0 (210)	3,335.0 (230)	3,335.0 (230)	8.2
2,247.5 (155)	2,247.5 (155)	2,247.5 (155)	2,247.5 (155)	
70	70	70	70	8.4

Noise

Noise at operator ear (measured by PREN 12053)

unit:dB(A)

Model	Noise Level[unit:Db(A)]
	Sound Pressure Level at operator's Ear(Leq)
CB40X-7	PREN 12053
CB45X-7	70.1
CB50X-7	

* Test Model : CB50X-7

Capacity Chart (Not used in Australia)

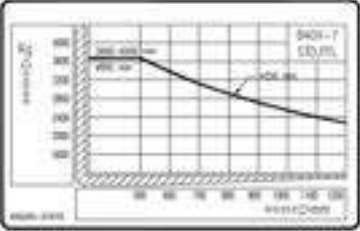
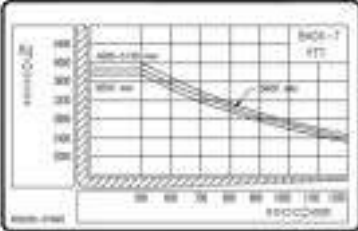
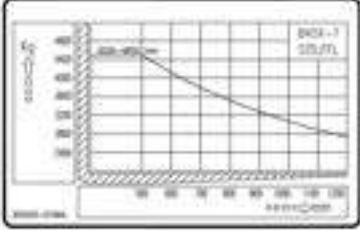
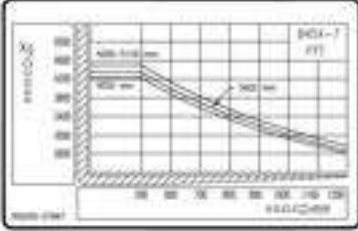
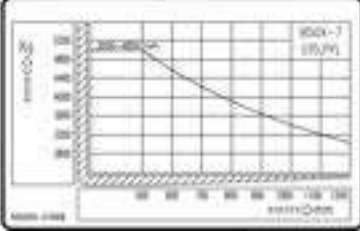
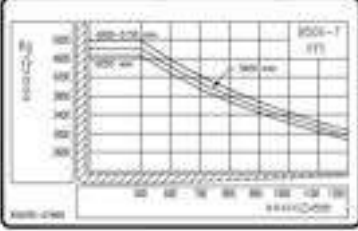
MODEL	STD, FFL	FFT
CB40X-7	 <p data-bbox="202 555 359 576">A. 3000 – 4850 mm MAST</p>	 <p data-bbox="617 555 941 596">A. 4000 – 4150 mm MAST C. 6050 mm MAST B. 5600 mm MAST</p>
CB45X-7	 <p data-bbox="202 887 359 908">A. 3000 – 4850 mm MAST</p>	 <p data-bbox="617 887 941 928">A. 4000 – 5150 mm MAST C. 6050 mm MAST B. 5600 mm MAST</p>
CB50X-7	 <p data-bbox="202 1206 359 1227">A. 3000 – 4850 mm MAST</p>	 <p data-bbox="617 1206 941 1248">A. 4000 – 5150mm MAST C. 6050 mm MAST B. 5600 mm MAST</p>

Capacity Chart - With Side Shifter (Hook on) (Not used in Australia)

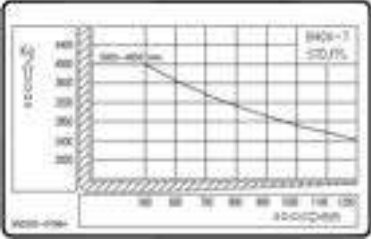
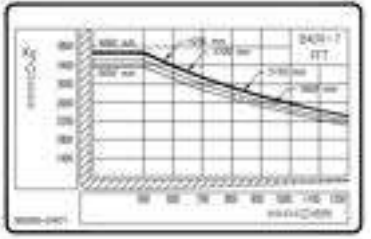
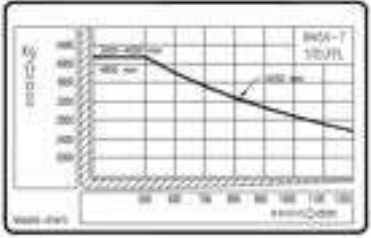
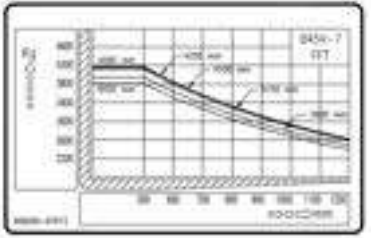
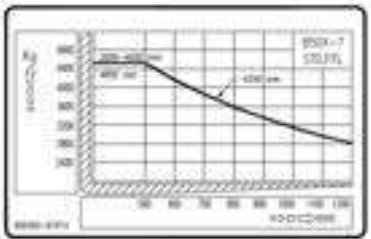
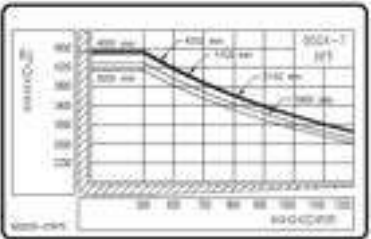
MODEL	STD, FFL	FFT
CB40X-7	 <p data-bbox="202 598 535 651"> A. 3000 – 4000 mm MAST C. 4850 mm MAST B. 4250 mm MAST </p>	 <p data-bbox="620 598 941 667"> A. 4000 mm MAST D. 5150 mm MAST B. 4250 mm MAST E. 5600 mm MAST C. 4700 mm MAST F. 6050 mm MAST </p>
CB45X-7	 <p data-bbox="202 951 535 987"> A. 3000 – 4000 mm MAST C. 4850 mm MAST B. 4250 mm MAST </p>	 <p data-bbox="620 951 941 1007"> A. 4000 mm MAST D. 5150 mm MAST B. 4250 mm MAST E. 5600 mm MAST C. 4700 mm MAST F. 6050 mm MAST </p>
CB50X-7	 <p data-bbox="202 1289 535 1326"> A. 3000 – 4000 mm MAST C. 4850 mm MAST B. 4250 mm MAST </p>	 <p data-bbox="620 1289 941 1345"> A. 4000 mm MAST D. 5150 mm MAST B. 4250 mm MAST E. 5600 mm MAST C. 4700 mm MAST F. 6050 mm MAST </p>

Operator's Warning and Identification Plate

Familiarise yourself with the information on the Identification, Lift Capacity and Attachment Plates. Do not exceed allowable lift truck working capacity load ratings.

Operator's Warning Plate



Located on the left side of the operator's handle at the front view.

Identification, Lift Capacity and Attachment Plate



Lift Truck Capacity Rating

DO NOT exceed allowable lift truck working capacity load ratings.

The capacity of the lift truck is given by weight and

distance to the load centre. For example: a capacity of 1200kg(2540 lb) at 600mm(24in) means that the lift truck can lift 1200kg(2640lb) if the load centre is 600 mm (24in) from both the vertical and horizontal faces of the forks.

Before attempting to lift any load, ensure that the weight and load centre combination is within the capacity of the lift truck as shown on the capacity rating plate. To determine the load centre measure the distance from the face of the carriage to the gravitational centre of the load.

The rated capacity on the plate refers to the capacity of the lift truck as it left the factory. Subsequent changes of any form to the equipment or battery can alter the lift truck's rating.

The rated capacity of the lift truck applies to operating conditions where the lift truck is on level ground. The capacity of the lift truck is reduced on inclines.

Below are abbreviations that may appear on the Identification, Lift Capacity and Attachment Plate and their meanings.

Mast Abbreviations

The identification plate indicates the type of mast installed on the lift truck when it left the factory. The type of mast is indicated by an abbreviation.

- STD** - Standard Mast(single inner member, low free lift).
- FF** - Full Free Mast (single inner member, high free lift with primary cylinder).
- FFT** - Triple Lift Mast (two inner members, high free lift with primary cylinder).
- QUAD** - Quadruple(Quad) Mast(three inner members, high free lift with primary cylinder).
- SPEC** - Special Mast, such as non-telescopic or double mast, not within the other classifications.

NOTE: When only a mast-type is listed on the identification plate, a standard carriage and forks are used.

Attachment Abbreviations (includes Special Forks)

- SC** - Special Carriage-increased width, height or outreach.
- SSS** - Shaft-type Sideshift Carriage.
- HSS** - Hook-type Sideshift Carriage.
- ISS** - Integral type Sideshift Carriage.
- ISFP** - Integral Shifting type Fork Positioner.
- CW** - Special Counterweight.
- SF** - Special Forks.

NOTE: Numbers following this abbreviation indicate number and/or length of forks.

SS-SWS - Sideshift-Swing Shift.

RAM - Ram or Boom

ROTC - Rotating Carriage.

DBCBH - Double Cube Block Handler

- HFP** - Hydraulic Fork Positioner, Non Sideshift.
- CR** - Crane Arm or Crane Boom.
- TH** - Tyre Handler.
- CTH** - Container Top Handler.
- CSH** - Container Side Handler
- LP** - Load Push Device, Non Sideshift.
- LPP** - Load Push-Pull Device, Non Sideshift.
- C** -General Clamp (other than Bale, Carton or Roll).
- BC** - Bale Clamp.
- CC** - Carton Clamp.
- RC** - Roll Clamp.
- LS** - Load Stabiliser.
- LH** - Log Handler.
- PWH** - Pulp Wood Handler.
- SS-ST** - Sideshift-Side Tilt Carriage.

Operator's Station and Monitoring Systems

Read and understand the "Safety", "Operation" and "Maintenance" sections before operating the lift truck.

Key Switch



The key switch is located on the right side of the steering column.

OFF - Turn the key switch to OFF (1) to disconnect the electrical circuits.



ON - Turn the key switch the ON (2) to connect the electrical circuits. If the key switch is left in the ON position when the operator leaves the lift truck, the LCD display will show a flashing "EE".



The power steering pump motor is activated when the key switch is turned to ON and the seat switch is closed.

NOTE: The power steering pump motor will shut off if the directional lever is left in NEUTRAL and no control levers are actuated for approximately six seconds.

The motor will be turned on when any control lever is used.

Seat Switch



The seat switch is located under the operator's seat.



OPEN - When the operator's seat is in the up position the electrical circuits are disconnected.



CLOSE - When the operator's seat is in the down position(operator seated) the electrical circuits are connected.

The power steering pump motor is activated when the key switch is turned to ON and the seat switch is closed.

Monitoring Systems Indicator(Compact Display)



Display Segments

The display gives the following information about the operating state of the system:



Lift truck speed (expressed in kmh or mph)



Handbrake active, indicated by the warning symbol



Safety contact open, indicated both by EE blinking message visualized in

timemeter area and by relative symbol.

With any directional switch active and safety contact still open, lift truck can't be moved, even after seat switch is closed; in such a case, after safety contact is closed, the symbol disappears.

EE code disappears only after active directional switch is turned off.



Time meter or, otherwise, milometer



Steering angle



Maintenance time expiry, indicated by warning symbol



Slow speed operation



Indicated by Lift truck speed level, range from 0 (NO speed) to 9 (MAXIMUM speed) segment, as in symbol



Battery level, indicated by a 9 segments symbol.



Low oil level of the brakes.

In following Table 1, you can read the generic relation between battery charge level and number of visualized bars. See Table 2 in case of a 80V system. Display signals with alarm code EL the fact battery is completely discharged.

Relation between battery charge level and number of visualized bars

Table 1 : Case of a generic system

DISPLAY INDICATION	BATTERY CHARGE LEVEL
No segments	Discharged battery
1 flashing segment	10 %
1 segment	20 %
2 segments	30 %
3 segments	40 %
4 segments	50 %
5 segments	60 %
6 segments	70 %
7 segments	80 %
8 segments	90 %
9 segments	Full charged battery

Table 2 : Case of a 80V system

BATTERY CHARGE LEVEL	BATTERY VOLTAGE [V]
Discharged battery	Voltage < 75.7 V
10 %	75.7 V ÷ 76.5 V
20 %	76.5 V ÷ 77.3 V
30 %	77.4 V ÷ 78.2 V
40 %	78.3 V ÷ 79.1 V
50 %	79.2 V ÷ 80.0 V
60 %	80.1 V ÷ 80.9 V
70 %	81.0 V ÷ 81.8 V
80 %	81.9 V ÷ 82.7 V
90 %	82.8 V ÷ 83.6 V
Full charged battery	Voltage > 83.6 V

Table 3 : Contraction for dot matrix display. Alarm Code

Display Code	Description	Contraction
17	Main breaker fault	CONTACTOR FAULT
60	Battery/inverter mismatch	BATT MISMATCH
61	Blocking overtemperature of right motor(over 165℃)	R-MOTOR SHUTDOWN
62	Blocking overtemperature of left motor(over 165℃)	L-MOTOR SHUTDOWN
65	Blocking overtemperature of pump motor(over 165℃)	P-MOTOR SHUTDOWN
76	Pump motor Encoder	P-MOTOR ENCODER.
77	Wrong right traction motor thermal switch	R-M TEMP SENSOR
78	Wrong left traction motor thermal switch	L-M TEMP SENSOR
79	Wrong pump motor thermal probe	P-M TEMP SENSOR
80	Wrong right traction module thermal probe	R-INV T SENSOR
81	Wrong left traction module thermal probe	L-INV T SENSOR
82	Wrong pump module thermal probe	P-INV T SENSOR
83	CRC fault	CRC FAULT
84	Bank CRC restored	CRC RESTORED
A	Capacitors not charged : fast charge	FAST CHARGE
A	Trans.precharge in Short / Cap. Too charged	TOO CHARGED
A	Capacitors not charged : slow charge	CAP SLOW CHARGE
A	Capacitors not charged : time out	TIME OUT CHARGE
A	Capacitors not charged	CAP NOT CHARGED
E1	Drive right module Overtemperature	R-INV OVERTEMP
E2	Drive left module Overtemperature	L-INV OVERTEMP
E3	Pump module Overtemperature	P-INV OVERTEMP
E4	Drive right motor Overtemperature	R-MOTOR OVERTEMP
E5	Drive left motor Overtemperature	L-MOTOR OVERTEMP
E6	Pump motor Overtemperature	P-MOTOR OVERTEMP
EE	Wrong start	WRONG START
EE (FLASHING)	Seat switch	SEAT SW OPEN
EL	Low battery voltage	LOW BATT VOLT
F	Wrong Eeprom	EEPROM FAULT
F	WD Timer/Enable micro signals	WD TIMER FAULT

Display Code	Description	Contraction
F	Serial communication	COMM FAULT
F0	Maximum battery voltage	MAX BATT VOLT
F1	Minimum battery voltage	MIN BATT VOLT
F2	Pedal trimmer fault	ACCEL FAULT
F3	Drive right module Desat/overcurrent	R-INVERTER FAULT
F4	Drive left module Desat/overcurrent	L-INVERTER FAULT
F5	Pump module Desat/overcurrent	P-INVERTER FAULT
F6	Drive right motor current Offset	R-MOTOR I OFFSET
F7	Drive left motor current Offset	L-MOTOR I OFFSET
F8	Pump motor current Offset	P-MOTOR I OFFSET
F9	Steer sensor fault	STEER SENSOR OUT
FA	5V encoders not ok	5V NOT OK
Fc	Drive right motor Encoder	R-MOTOR ENCODER
Fd	Drive left motor Encoder	L-MOTOR ENCODER
FE	24V out	24V NOT OK
FH	12V out not ok	12V NOT OK
FL	Pump input on at the start	PUMP SIGN ON
b1	EPB fault	EPB FAULT
b2	EPB dynamic overuse	EPB DYNAMIC MISUSE
b3	EPB motor diagnosis	EPB NO CURRENT
b4	EPB EEPROM	EPB EEPROM FAULT
b5	EPB overvoltage	EPB OVERVOLTAGE
b6	EPB cable fault	EPB CABLE FAULT
b7	EPB operation fault	EPB MOVING FAULT
b8	EPB Stroke	EPB STROKE FAULT
b9	EPB low stiffness	EPB TIMEOUT
bA	EPB voltage fault	EPB VOLTAGE ERROR
bC	EPB voltage reading error	EPB SPIKE FAULT
bd	EPB overtemperature	EPB OVERTEMP
bE	No EPB control signal	EPB NO SIG
bF	EPB control signal fault	EPB SIG RANGE ERR
bH	EPB temp fault	EPB TEMP ERROR
bJ	Brake pad wear	EPB PAD WARNING
bL	EPB overuse	EPB MISUSE
bP	EPB Initialized	EPB NOT INITIAL

Lift truck operation mode



Pressing E-S-H button, you can set energetic operating mode for your system.

This function is enabled using EYE menu named Calibration – ESH, to select desired operating mode. In particular you can choose between E-S-H or PROGRAMMABLE WORKING :

- Pressing E-S-H (economic, standard, high) button, you change energetic mode and update related parameters with a value, corresponding to selected operating mode, that operator can't modify.
- Pressing PROGRAMMABLE WORKING you can manage 3 further options (limit 1, limit 2, and limit 3). You can set parameters value, that are expressed in per cent of high energetic mode; changing active limitation (among L1, L2 or L3), related per cent data are used to calculate actual parameters value.

NOTE: Percent values can be modified only with EYE Calibration – E-S-H menu.

NOTE: Pressing PROGRAMMABLE WORKING you can manage economic, standard or high operating mode too.

COMPACT display shows different symbols in function of selected energetic mode:



- E-S-H management disabled: no symbol visualized.

- E-S-H management enabled: active mode is indicated by symbol.

- PROGRAMMABLE WORKING management enabled: in case you have chosen one of L1, L2 or L3 operating modes, and lift truck is stopped, one of the segments of speed indicator symbol (see Table 4) blinks to show selected energetic mode.

Table 4 : selected energetic mode

DISPLAY VISUALISATION (from symbol left side)	OPERATING MODE
1st segment	L1 (Limit 1)
5st segment	L2 (Limit 1)
9st segment	L3 (Limit 1)



Otherwise symbol indicates, as usual, selected operating mode.



as usual, if lift truck is moving, symbol indicates speed level

NOTE: if active mode is one of L1, L2 or L3 limitations and you change operating mode (from PROGRAMMABLE WORKING to E-S- H), software automatically sets operating mode to economic one

Alarm message, indicated by an alpha-numerical code in the display area where usually lift truck speed appears.

See Table 3 for the meaning of alarm codes.



Over-temperature warning, indicated by the warning light. In case the temperature of power transistors exceeds the limit and relative light blink.

If this light is on, there is possibility that cooling fan is breakdown. Inspect cooling fan.

Hour meter separation point, usually blinking, stops in following cases:

- Seat switch open.
- Serial communication between display and control unit not active
- Main breaker open

Turning your lift truck on, some alphanumeric codes, visible for 3 seconds, appear where usually is visualized speed indicator symbol; those codes help to identify system in use (see Table 5).

Where usually is visualized hour meter, on left side appears feed voltage in VDC, and on right side, maximum weight industrial truck can lift, expressed in quintals.

Table 5

CODE	MEANING
C0	4 WHEEL
80	BATTERY VOLTAGE
50	MAX. CAPACITY

LED Indicators

On left side, COMPACT display has four LED indicators which, when switched on, give information as follows:



Alarm message; red color LED



Message of lamps; green color LED



Indicator lights activated; green color LED(OPTION)



Seat Belt warning (Option) : red color LED for 10 seconds.

NOTE: Alarm LED  : managed as follows:

- Display normally working: LED lights up briefly switching on/off your system
- Display not communicating with control board: after 3 seconds from the moment in which the communication stops, alarm LED brightens
- Display board microprocessor not working: alarm LED brightens.

No Alarm, No Movement

In case the truck does not move forward or reverse direction, check to see if the service brake switch is activated.

Front and Rear Floodlights Switch



Located on the right side of the instrument panel, below the display panel.



OFF - Push down on the left side of the switch to turn both front and rear flood lights off.



Front Floodlights - Push down on the right side of the switch, to the first position, to turn the front floodlights on.



Front and Rear Floodlights - Push down on the right side of the switch, to the second position, to turn both the front and rear floodlights on. The rear floodlights are optional.

Horn Button



Located in the centre of the steering wheel. Push in on the horn button to sound the horn.

Tilt Steering Column



Located on the lower front of the steering column.

To adjust the steering column, raise the handle(1) and move the steering column to the desired position. Release the handle and the steering column will remain in the desired position.

Seat Adjustment

Adjust the seat at the beginning of each shift or when changing operators.

Adjust the seat to allow full travel of all pedals with the operator seated against the seat back.

The seat must be adjusted with the operator seated.

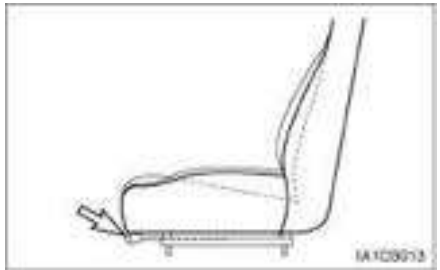

Move the lever to adjust the seat forward or backward. Release the lever. Move the seat slightly to lock it.

Emergency Switch (If Equipped)

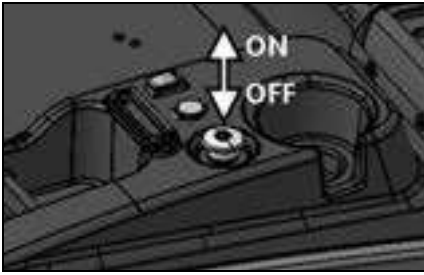

OFF - Push the emergency switch button to disconnect the electrical circuits. (It must be done after the key switch is turned off. If use often this button by the key switch, the electric system can make a problem. So, this button uses in emergency certainly).



ON - Pull the emergency switch button to connect the electrical circuit.

Lift Truck Controls

Parking Brake

NOTICE

Do not engage the parking brake while the lift truck is moving unless an emergency arises. The use of the parking brake as a service brake in regular operation will cause severe damage to the parking brake system.

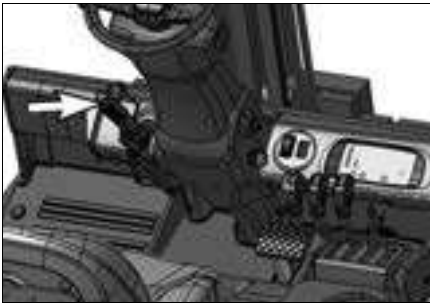

Parking Brake - The parking brake lever is located on the left side of the cowl.



Parking Brake Engaged - Pull the parking brake lever (1) up, which will engage the interlock switch that shuts off power to the drive motor.



Parking Brake Disengaged - Push the parking brake lever (2) down to release the parking brake.

Electric Parking Brake (If Equipped)

NOTICE

Do not engage the parking brake while the lift truck is moving unless an emergency arises. The use of the parking brake as a service brake in regular operation will cause severe damage to the parking brake system.

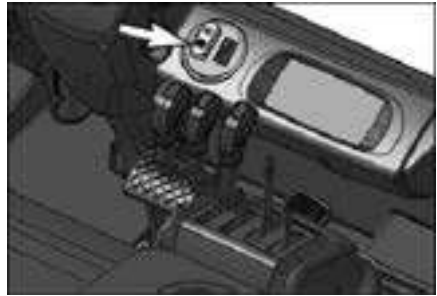

Parking Brake - The parking brake button is located on the left side of the Instrument Panel.



Parking Brake Engaged - Push the parking brake button (1), or when the operator leaves the seat, or there are no operational movements for 10 secs which will engage the parking brake.



Parking Brake Disengaged - Push the parking brake button or accelerator pedal to release the parking brake.

Service Brake Pedal

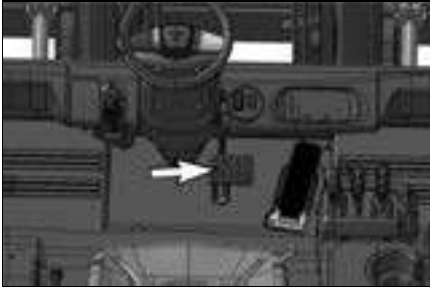

Service Brake - The service brake pedal is located on the floor of the operator's compartment.



Depress the service brake pedal to slow or stop the lift truck. Drive circuit will be interrupted while the pedal is depressed.



Release the service brake pedal to allow the lift truck to move.

Accelerator Pedal

NOTICE

The service brake and accelerator pedals should not be used at the same time, except for emergency situations. Use of both the brake and accelerator pedals at the same time may cause the drive motor to overheat.

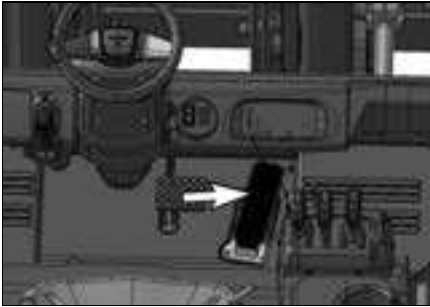

Accelerator Pedal - The accelerator pedal is located on the floor of the operator's compartment.

Push down the pedal to increase travel speed.

If the accelerator pedal is depressed before the key switch is turned to the ON position, the lift truck will not move until the pedal is released and depressed again.

Release the pedal to decrease travel speed.

Film for function of pedals (if equipped)



This plate shows the function of the brake and accelerator pedals.

Directional control forward/reverse switch



Forward (1) – Push the forward/reverse switch forward to drive the truck forward.



Neutral (2) – If the forward/reverse switch is at the neutral position, the truck does not travel.

The forward/reverse switch must be at the neutral position when the driver is off from the driver's seat or the key switch is OFF. The lift truck does not move until the accelerator pedal is released and the directional control forward/reverse switch is returned to neutral position. Forward/reverse switch for direction change.

NOTE: Wait Mode of Operation - This condition will go into effect when the following occurs. The seat switch is closed, key switch is on and the directional control forward/reverse switch is left in NEUTRAL for more than five seconds, with no operator input to any control.

The line contactor will open and the power steering motor will turn off to conserve energy. The lift truck will remain in this mode until the operator moves the directional control forward/reverse switch, pushes on the accelerator pedal and/or moves any control valve lever.



Reverse (3) - Pull the forward/reverse switch to drive the truck reverse

NOTE: The directional control forward/reverse switch can be used for electrical braking (plugging). To slow or stop the lift truck when traveling in either direction, move the directional control forward/reverse switch to the opposite direction of travel while keeping the accelerator depressed. The lift truck will slow to a complete stop and then accelerate in the opposite direction.

Directional Control Lever (If Equipped)



Forward(1) - Push the lever forward.

The lift truck will move forward.



Neutral(2) - Move the lever to centre position. The lift truck should not move when lever is in neutral.

If the operator leaves the seat, or turns the key switch off, the lever must be returned to NEUTRAL. The lift truck will not move until accelerator pedal is released and lever is returned to NEUTRAL.

NOTE: Wait Mode of Operation-This condition will go into effect when the following occurs. The seat switch is closed, key switch is on and the directional control lever is left in NEUTRAL for more than five seconds, with no operator input to any control.

The line contactor will open and the power steering motor will turn off to conserve energy. The lift truck will remain in this mode until the operator moves the directional control lever, pushes on the accelerator pedal and/or moves any control valve lever.

Reverse(3) - Pull the lever toward the operator. The lift truck will move in reverse.

NOTE: The directional control lever can be used for electrical braking(plugging). To slow or stop the lift truck when traveling in either direction, move the directional control lever to the opposite direction of travel while keeping the accelerator depressed. The lift truck will slow to a complete stop and then accelerate in the opposite direction.

When the operator raises off the seat (seat switch opens) while the lift truck is in motion, the drive motor will lose power. When this occurs, release the accelerator, close the seat switch (operator seated), move the directional control lever to NEUTRAL and then to desired direction of travel. Push down on the accelerator.

Lift Control Lever



The forks' lift control is located at the operator's right side front. The lift control lever is the lever at the left.



Lower(1) - Push the lever forward smoothly to lower the lift forks.



Hold(2) - Release the lift lever. The lever will return to the centre(hold) position and the forks will remain in the position they are in.



Raise(3) - Pull the lever back smoothly to raise the lift forks.

NOTE: To prevent a sudden change of position of the load, operate all lift, tilt and attachment controls smoothly.

Tilt Control Lever



The forks' tilt control is located at the operator's right side front. The tilt control lever is the lever at the centre.



Tilt Forward(1) - Push the lever forward smoothly to tilt the forks forward.



Hold(2) - Release the tilt lever. The lever will return to the centre(hold) position and the forks will remain in the position they are in.



Tilt Back(3) - Pull the lever back smoothly to tilt the forks back.

NOTE: To prevent a sudden change of position of the load, operate all lift, tilt and attachment controls smoothly. Never tilt an elevated load forward past vertical.

Sideshift Attachment Control (If Equipped)



The sideshift attachment control is located at the operator's right side front. The sideshift attachment control lever is the lever at the right.



Sideshift Left(1) - Push the lever forward smoothly to shift the carriage to the left.



Sideshift Hold(2) - Release the sideshift attachment lever. The lever will return to the centre(hold) position and sideshifting action will stop.



Sideshift Right(3) - Pull the lever back smoothly to shift the carriage to the right.

NOTE: To prevent a sudden change of position of the load, operate all lift, tilt and attachment controls smoothly

Before Operating the Lift Truck

Walk - Around Inspection

For your own safety and maximum service life of the lift truck, make a thorough walk-around inspection before mounting the lift truck or starting to move it.

Look for such items as loose bolts, trash build-up, oil leaks, condition of tyres, mast, carriage, forks or attachments.

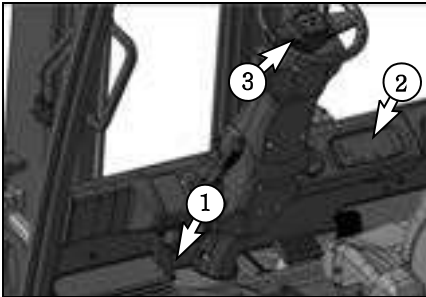

1. Inspect the operator's compartment for loose items and clean any mud or debris from the floor plates for safe footing.
2. Inspect the instrument panel for damage to the indicator display.
3. Test the horn and other safety devices for proper operation.

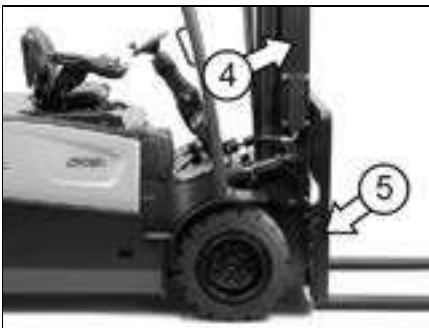

4. Inspect the mast and lift chains for wear, broken links, pins and loose rollers.
5. Inspect the carriage, forks or attachments for wear, damage and loose or missing bolts.



6. Inspect the tyres and wheels for proper inflation, cuts, gouges, foreign objects and loose or missing nuts.
7. Inspect the overhead guard for damage, loose or missing mounting bolts.
8. Inspect the hydraulic system for leaks, worn hoses or damaged lines.
9. Inspect the drive axle housing and the ground for oil leaks.
10. Inspect common parts and drive axle, mast etc. for grounded, loosen or missing mounting bolts.



11. Inspect the battery compartment for loose connections, frayed cables and properly secured battery restraint.

WARNING

Batteries give off flammable fumes that can explode.

Do not smoke when observing the battery electrolyte levels.

Electrolyte is an acid and can cause personal injury if it contacts skin or eyes.

Always wear protective glasses when working with batteries.



- 12. Disconnect the battery. Tilt the steering column to the full upright position and move the seat fully rearward.
- 13. Raise the seat and cover assembly and latch the cover to the cowl.
- 14. Observe the battery electrolyte level for proper level. Lower the seat and cover assembly and connect the battery to the lift truck.

⚠ WARNING

Personal injury may occur from accidents caused by improper seat adjustment. Always adjust the operator's seat before operating the lift truck.

Seat adjustment must be done at the beginning of each shift and when operators change.



- 15. Position the seat by operating the lever and moving the seat forward or backward to a comfortable position.



- 16. Adjust the steering wheel to comfortable position. Grasp the steering wheel and raise the handle to release the steering column. PULL the steering column BACK or PUSH FORWARD to obtain the most comfortable position. RELEASE the knob and make sure the steering column is locked in this position.



When directional control lever is equipped.

17. With the seat switch closed and the directional lever in NEUTRAL, turn the key switch ON. Observe the battery discharge indicator.



18. Make sure the battery is charged before operating the lift truck. A fully charged battery will cause "9 Segments" to be displayed on the BDI display.

Better Battery Performance

NOTICE

The lift truck operator must not start a shift with a battery that has been taken off a charger too soon.

A battery should never be disconnected from a charge until the charge cycle has been completed.

The batteries that have been fully charged should have a tag attached for identification.

In Operation, a battery should be discharged then recharged in 8 to 12 hours, depending on the charger type. Then, they should be allowed to cool and stabilise 4 to 8 hours. Repeated undercharging must be prevented. It can damage the battery.

If there is an indication of low battery operation, the lift truck operator should return the lift truck to the battery charging area.

NOTE: Refer to the Maintenance Section of this guide for additional battery exchanging and charging information.

Lift Truck Operation

Be sure no one is working on or near the lift truck.

Keep the lift truck under control at all times.

Reduce speed when maneuvering in tight quarters or when braking over a rise.

Do not allow the lift truck to overspeed downhill. Use the service brake pedal to reduce speed when traveling down hill.

NOTICE

Do not move directional control lever from one direction to the other(plug) when the drive wheels are off the ground and rotating at full speed.

Damage can occur to the control panel.

1. Adjust the operator's seat.



When directional control lever is equipped.

2. Move the directional control lever into the NEUTRAL position, if it is not already in this position.

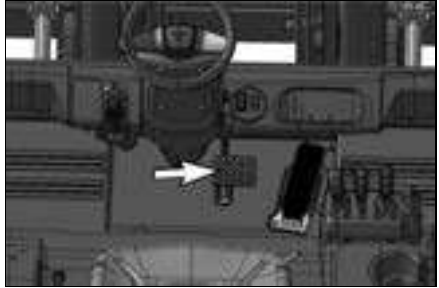

3. Push down on the service brake pedal and Prelease the parking brake.



4. Turn the key switch to the ON position. Raise the attachments.



5. Move the directional control lever to the desired direction of travel.

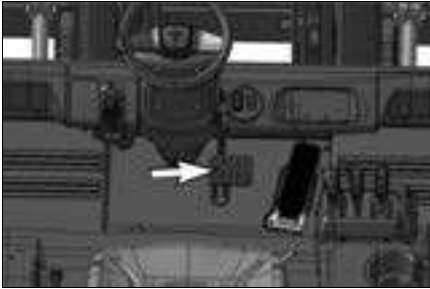

6. Release the service brake pedal.

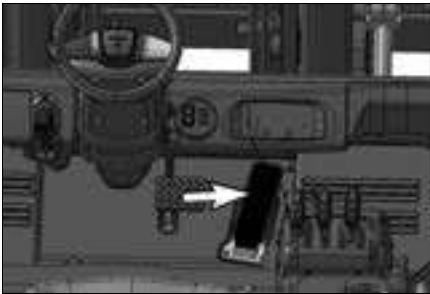

7. Push down on the accelerator pedal to obtain the desired travel speed. Release the pedal to decrease travel speed.
8. To change the lift truck direction of travel, electrical braking(plugging) can be used to slow or stop the lift truck.

Electrical Braking (Plugging)



When directional control lever is equipped

To slow, stop or change direction when traveling in either direction, move the directional control lever (1) to the opposite direction while keeping the accelerator pedal (2) depressed.

The Micro-controller senses that the motors are turning opposite to the lift truck and immediately goes into the plugging mode.

Rotation of the motors is retarded at a predetermined rate by electrical braking (plugging).

If the accelerator pedal is kept depressed, the Microcontroller will slow the lift truck to a complete stop and then accelerate in the opposite direction.

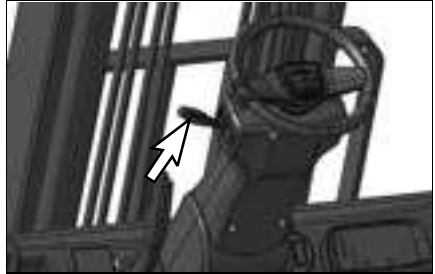

1. Move the directional control lever to the opposite direction of lift truck travel.

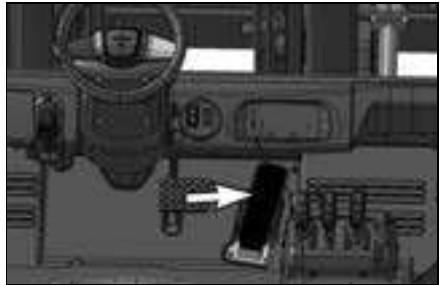

2. Hold the accelerator pedal down until the lift truck nearly comes to a complete stop. Release the accelerator pedal.
3. Push down on the service brake pedal to bring the lift truck to a complete stop and hold it.
4. If a change of direction is desired, continue to push down on the accelerator pedal until the desired travel speed in the opposite direction is obtained.

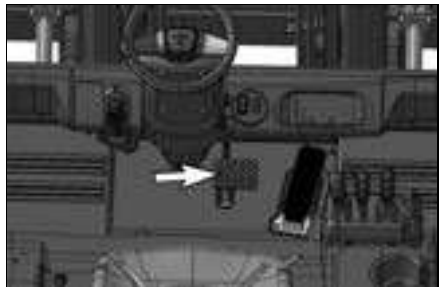

5. To stop the lift truck where conditions do not permit electrical braking(plugging). Release the accelerator pedal (1). Push down on the service brake pedal (2) and bring the lift truck to a smooth stop.

Steering Knob (If Equipped)

There is a steering knob available for inclusion with new truck deliveries. This option is solely intended for slow travel situations when two handed steering is not possible due to hydraulic operations.



WARNING

Loss of stability can occur when a lift truck steering wheel is rotated quickly while the truck is in motion. A steering knob will assist with easy rotation of the steering wheel, but if a steering knob is improperly used (e.g., rotating the steering wheel quickly while the truck is in motion), this can contribute to truck instability and a tip over. A steering knob is intended for slow travel maneuverability **ONLY**.

Mono-Ped Control System (Option)

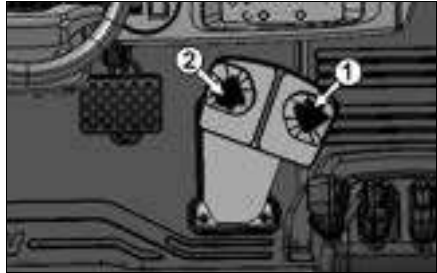

Forward-Push the left side (2) of the pedal for FORWARD direction travel.



Neutral-The lift truck should not move when the Mono-Ped pedal is released.



Reverse-Push the right side (1) of the pedal for REVERSE direction travel.

The MONO-PED pedal controls the speed and direction of the lift truck. Pushing on the right side of the pedal (1) causes the lift truck to move in REVERSE. The optional reverse lights and optional back-up alarm will be ON in the REVERSE position. Pushing on the left side of the pedal (2) causes the lift truck to move in FORWARD. The speed of the truck increases as the pedal is depressed

Finger Tip (Option)

Lift Control knob



Lower - Push the knob forward smoothly to lower the lift forks.



Hold - Release the lift knob. The knob will return to the centre(hold) position and the forks will remain in the position they are in.



Raise - Pull the knob back smoothly to raise the lift forks.

NOTE: To prevent a sudden change of position of the load, operate all lift, tilt and attachment knobs smoothly.

Tilt Control knob



Tilt Forward - Push the knob forward smoothly to tilt the lift forks forward.



Hold - Release the tilt knob. The knob will return to the centre(hold) position and the forks will remain in the position they are in.



Tilt Back - Pull the knob back smoothly to tilt the lift forks back.

NOTE: To prevent a sudden change of position of the load, operate all lift, tilt and attachment knobs smoothly.

Sideshift Attachment Control



The side shift attachment controller is at the front-right side of the driver, and the side shift control lever is at the right as shown in the figure.



Side shift Left (1) – open the knob softly forward to move the carriage to the left.



Side shift Stop (2) - release the side shift knob. The knob will return to the HOLD position and side shifting operation will stop.



Side shift Right (3) - pull the knob softly forward reverse to move the carriage to the right.

NOTE: To prevent a sudden change of position of the load, operate all lift, tilt and attachment knobs smoothly.

Emergency Switch



OFF - Push the emergency switch button to disconnect the electrical circuits. (It must be done after the key switch is turned off)



ON - Pull the emergency switch button to connect the electrical circuit.

Directional Control Switch

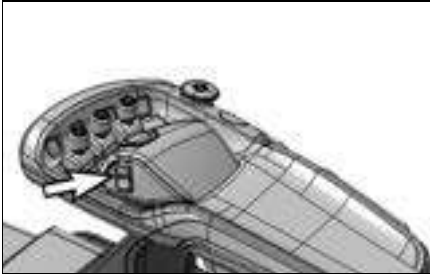

Forward - push the forward/reverse switch forward to drive the truck forward.



Neutral - if the forward/reverse switch is at the neutral position, the truck does not travel.

The forward/reverse switch must be at the neutral position when the driver is off from the driver's seat or the key switch is OFF. The forklift truck does not move until the accelerator pedal is released and the directional control forward/reverse switch is returned to neutral position.

NOTE: operation wait mode: - this mode is effective in the following condition While the driver is not driving, the seat switch is closed and the key switch is ON, and the directional control forward/reverse switch is at neutral for 5 s or longer

The circuit breaker opens and the power steering motor is shut down to save energy. The lift truck maintains the mode until the driver operates the directional control switch and step on the acceleration pedal or operated the control valve lever.



Reverse - pull the forward/reverse switch towards the driver to drive the lift truck reverse.

NOTE: The directional control forward/reverse switch may be used for electrical braking (plugging). To stop or low down the lift truck during travel, operate the directional control switch to the opposite direction of the travel. When the lift truck has slowed down sufficiently or stopped, accelerate the lift truck in the opposite direction.

If the driver stands up from the driver's seat while

the forklift truck is in operation, the seat switch will be activated and the drive motor will turned off after 3 s. In this case, release the accelerator pedal and close the seat switch, return the forward/reverse switch to neutral and then shift it to desired position in the respective direction. Then, step on the acceleration pedal.

Horn Button

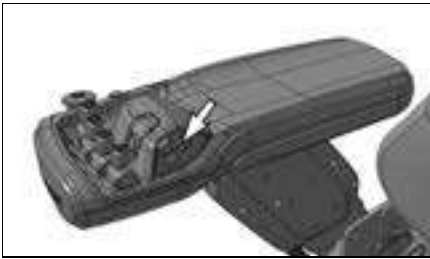

Located in the right side of the directional control switch. Push in on the horn button to sound the horn.

Auto Tilt Control (If Provided)



The auto tilt controller is at the rear side of the tilt knob. Press the auto tilt switch to turn on the switch lamp and push the tilt knob forward. The mast will stop at 90 degrees angle.

NOTE: To prevent sudden position shift of the load, operate the lift, tilting and side shift controller smoothly.

Auto Clamp Control (If Provided)



The auto clamp controller is at the rear side of the emergency switch. Pressing the auto clamp switch enables operation of the AUX2 knob. If not AUX2 operation signal is provided for 10 s after the trigger, the AUX2 will be locked. To reset the AUX2, press the auto clamp switch again. In addition, if no AUX2 operation signal is provided after key switch ON, the AUX2 will be locked up.

NOTE: To prevent sudden position shift of the load, operate the lift, tilting and side shift controller smoothly.

Adjustment of Armrest

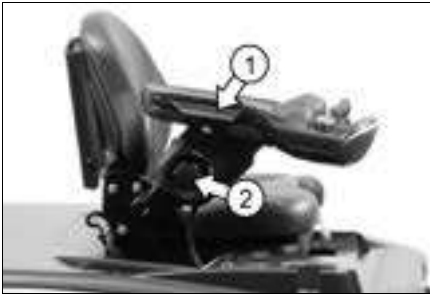

By using 2 knobs, adjust the position of the armrest to give the operator the best comfortable position of arm.

knob #1 - Forward and backward adjustment

knob #2 - Clockwise and Counterclockwise rotation adjustment

Forward and Backward Adjustment



1. Loosen the knob bolt(1).
2. Adjust the position of armrest forward or backward.
3. Tighten the knob bolt(1) to be locked tightly

Up and Down Adjustment



To move the armrest down, turn the knob(2) counterclockwise.



To move the armrest up, turn the knob(2) clockwise.

Hood Opening

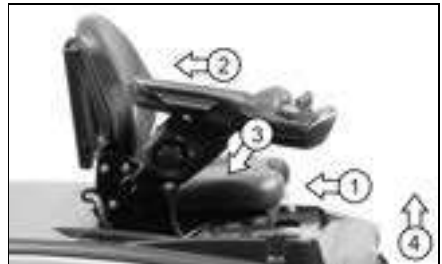

1. Slide the seat to the backward-most position.
2. Slide the armrest to the backward-most position.
3. Slide the armrest

Operating Techniques

NOTE: The photographs and line art used in the following Operating Techniques, are typical examples and may not apply to your particular lift truck.

Inching into Loads

1. Move the lift truck slowly forward into position and engage the load. Lift truck should be square with load, forks spaced evenly between pallet stringers and as far apart as load will permit.



2. Move the lift truck forward until the load touches the carriage



WARNING

The forklift truck must not be used to push loads or other vehicles.

Only the moving equipment supplied or the rear hook for towing must be used.

Lifting the Load



1. Lift the load carefully and tilt the mast back a short distance.
2. Tilt the mast further back to cradle the load.

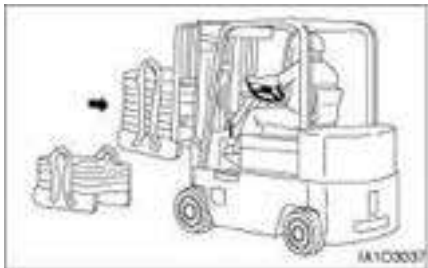

3. Operate the lift truck in reverse until the load is clear of the other loads.
4. Lower the load to the travel position before turning or traveling.

Traveling With or Without a load

When traveling with and without a load, travel with the fork as low as possible, while still maintaining good floor clearance height.



1. Carry the load as low as possible, while still maintaining ground clearance.



2. Travel with the load uphill on upgrades and downgrades.



3. For better vision, travel in reverse with bulky loads.

Lift Truck Turning

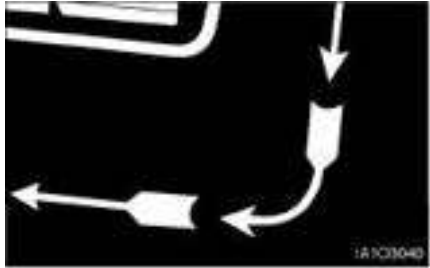

1. When turning sharp corners, keep close to the inside corner. Begin the turn when the inside drive wheel meets the corner.



2. When turning in narrow aisles, keep as far from the stockpile as possible when making a turn into the aisle. Allow for counterweight swing.

Unloading Lift Truck



1. Move the lift truck into the unloading position.
2. Tilt the mast forward only when directly over the unloading area.

⚠ WARNING

Do not tilt the mast forward with the load unless directly over the unloading area, even if the power is off.



3. Deposit the load and back away carefully to disengage the forks.
4. Lower the carriage and forks to either travel position or park position.

Lifting Drums or Round Objects

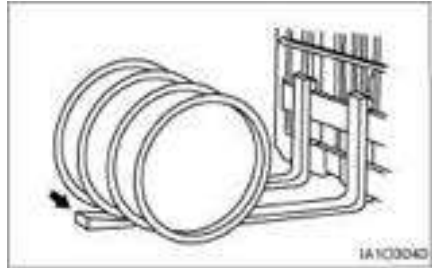

1. Block drums or round objects. Tilt mast forward and slide fork tips along the floor to get under the load.

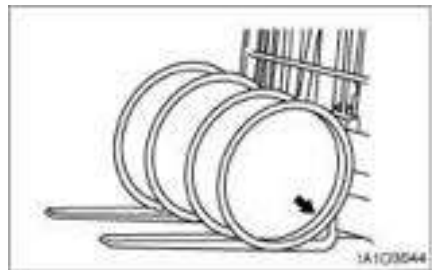

2. Tilt the mast back slightly until the load is cradled on the forks before lifting.
3. Lift the load to the travel position.

Safety instructions for attachments when transporting suspended load



⚠ WARNING

Swinging/wide loads and a reduced residual capacity can result in accidents.

Adapt the travel speed to the load, less than walking pace.

Secure swinging loads for example with lifting slings.

Reduce the residual capacity and have it certified by an expert.

Failure to follow the operation precautions may cause early damage to parts.

Safety instructions for attachments when transporting wide loads

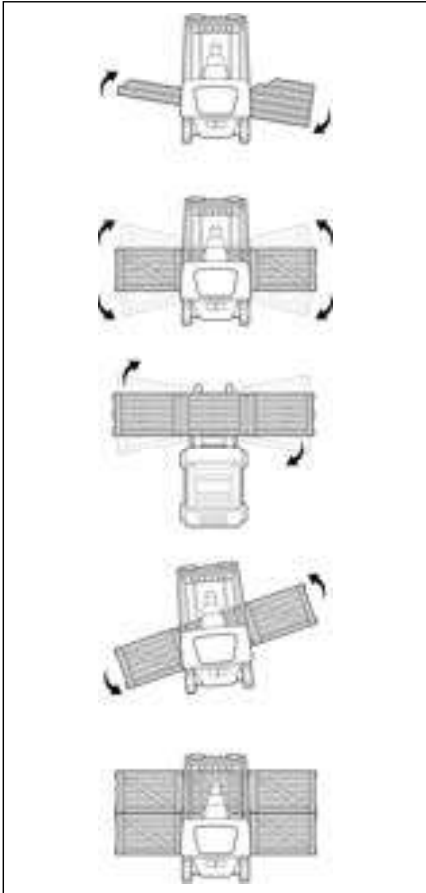

Load lateral centre of gravity

Where it is necessary to lift a wide load where the lateral load centre of gravity is unknown.

Do a test lift first to determine lateral centre of gravity and potential movement with the load during transport. Exercise extra caution when handling offcentre loads that cannot be centred.

Load Stability

Be careful when stopping or changing direction suddenly, lifting or lowering suddenly as wide loads could become unstable.

Load Swing

Be careful whilst travelling or turning, the load ends will swing wide. Make sure you have adequate clearance, and watch out for people in the area.

Load Shift

Be careful when turning, turn slowly to prevent load from shifting.

Visibility

When carrying a bulky load which blocks or restricts forward visibility the truck shall be driven with the load trailing and if necessary under the direction of a person who has visibility in the direction of travel, unless safe work practices allow otherwise.

Parking the Lift Truck

NOTICE

Parking or storage of electric lift trucks outdoor can cause lift truck system damage or failure.

Park or store all electric lift trucks inside a building to protect electrical system from moisture damage.

When leaving the operator's station, park the lift truck in authorised areas only. Do not block traffic.

Park the lift truck level, with the forks lowered and the mast tilted forward until the fork tips touch the floor. Block the drive wheels when parking on an incline.

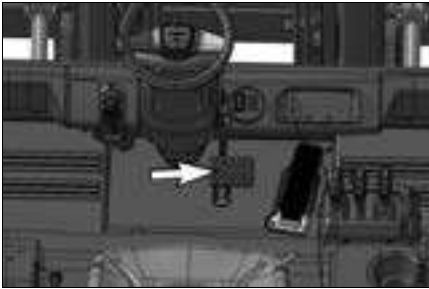

1. Apply the service brake to stop the lift truck.

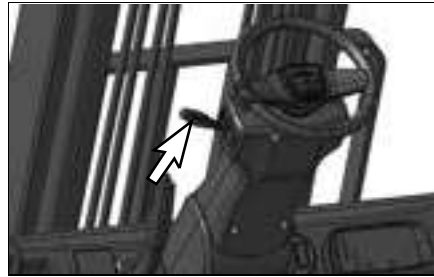

2. Move the directional control lever into NEUTRAL.

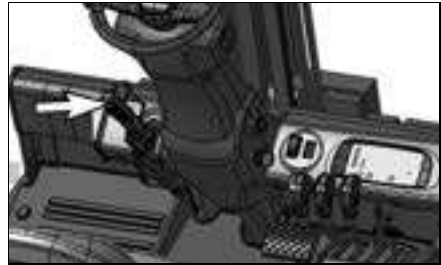

3. Engage the parking brake. (If equipped, Electric parking brake should be engaged. Please, refer next page.)



4. Tilt the mast forward and lower forks to the floor.



- 5. Turn key switch to OFF and remove the key.



- 6. Disconnect the battery.



- 7. Block the wheels if parking on an incline.

Parking Alarm Warning (If Equipped)

When leaving the operator's station without engaging the parking brake, a warning buzzer will sound.

Electric Parking Brake (If Equipped)



Parking Brake Engaged – Push the parking brake button (1), or when the operator leaves the seat, or there are no operational movements for 10 secs, which will engage the parking brake.

How to deal with failure of Electric Parking Brake (If equipped)

NOTICE

Do not execute following steps on an incline.

Block the drive wheels when conducting following steps on level ground.

When leaving the operator's station, park the lift truck in authorised areas only. Do not block traffic.

Park the lift truck level, with the forks lowered and the mast tilted forward until the fork tips touch the floor.

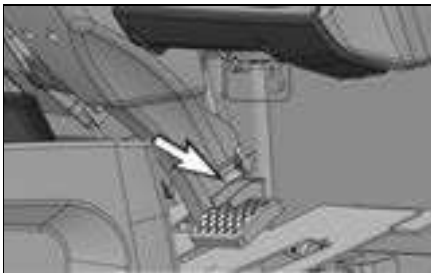
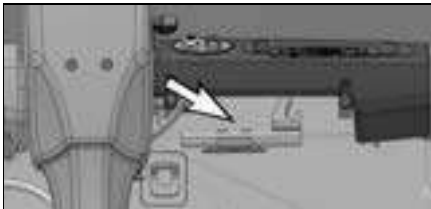

***How to deal with Electric Parking Brake failure temporarily** – First, Grab service pedal holding bracket locating under Instrument panel below. As picture, push the service brake pedal using the bracket and lock the pedal down using fixture marked as square in picture above and contact our service team.

Parking Brake Forced Release Method (If equipped)

NOTICE

Do not execute following steps on an incline.

Block the drive wheels when conducting following steps on level ground.

When leaving the operator's station, park the lift truck in authorised areas only. Do not block traffic.

Park the lift truck level, with the forks lowered and the mast tilted forward until the fork tips touch the floor.

If the parking brake is not released before towing the vehicle, it may cause damage to the tyres and driving system.

This procedure must carry out only when EPB fail.

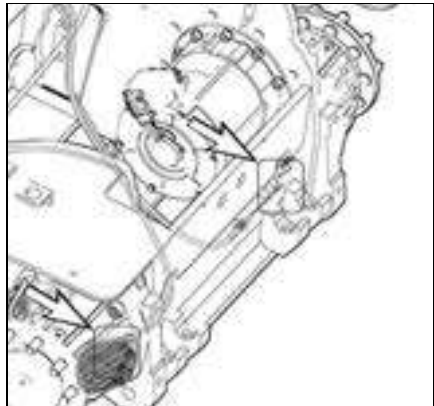

***How to do EPB Forced Release temporarily** – First, operate mast to secure a clear view of parking cable assembling in drive axle parking lever. Second, disassemble RH/LH parking cable from drive axle parking lever in the picture above and contact our service team.

Lift Fork Adjustment

⚠ WARNING

When adjusting the fork spread, be careful not to pinch your hand between forks and the carriage slot.

Hook-on type Fork



1. Move up the hook pin to the free position in each fork to slide the fork on the carriage bar.
2. Adjust the forks in the position most appropriate for the load and as wide as possible for load stability.
3. When adjusting the forks, make sure that the weight of the load is centred on the truck.
4. After adjustment, set the fork locks to keep the forks in place.

⚠ WARNING

Make sure the forks are locked before carrying a load.

Storage Information

Before Storage

To place the machine in storage for an extended period of time, the following measures must be taken to ensure that it can be returned to operation with minimal service.

1. After every part is washed and dried, the machine should be housed in a dry building. Never leave it outdoors. In case it has to be left outdoors, lay wooden boards on the ground, park the machine on the boards and cover it with canvas, etc.
2. Lubricate, grease and replace oil before storage.
3. Apply a thin coat of grease to metal surface (hydraulic piston rods.)
4. Cover batteries after removing terminals, or remove them from the machine and store separately.

During Storage

Drive the truck for a short period at least once a month. This coats moving part surfaces with a new film of oil. Charge the battery at this same time.

After Storage

After storage (when it is kept without cover or rust preventive and once is month operation has not been made), you should apply the following treatment before operation.

1. Remove the drain plug on hydraulic tank and drain mixed water.
2. Wipe off grease from hydraulic cylinder piston rod.
3. Measure specific gravity and check that battery is charged.
4. Drive at low speed to make sure inside of transfer is well oiled.

Transportation Hints

Shipping

Check travel route for overpass clearances. Make sure there is adequate clearance if the lift truck being transported is equipped with a high mast, overhead guard or cab.

To prevent the lift truck from slipping while loading, or shifting in transit, remove ice, snow or other slippery material from the loading dock and the truck bed before loading.

NOTICE

Obey all state and local laws governing the weight, width and length of a load.
Observe all regulations governing wide loads.

NOTICE

Remove ice, snow or other slippery material from the shipping vehicle and the loading dock.

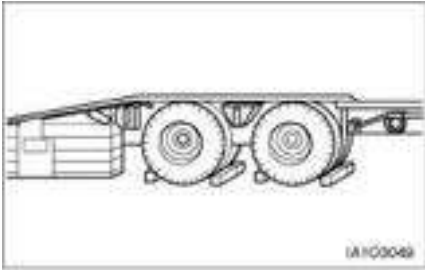

1. Always block the trailer or the rail car wheels before loading the lift truck.
2. Position the lift truck on the trailer or the rail car.
3. Apply the parking brake and place the transmission control in NEUTRAL.
4. Tilt the mast forward and lower forks to the floor.
5. Turn key switch OFF and remove the key.

6. Disconnect the battery.
7. Block the tyres and secure the lift truck with tiedowns.

Machine Lifting and Tiedown Information

NOTICE

Improper lifting or tiedowns can allow load to shift and cause injury and/or damage.

1. Weight and instructions given herein apply to lift trucks as manufactured by CROWN.
2. Use properly rated cables and slings for lifting. Position the crane for level lift truck lift.
3. Spreader bar widths should be sufficient to prevent contact with the lift truck.
4. Use the tiedown locations provided for lift truck tiedown.

Check the state and local laws governing weight, width and length of a load.

Contact your CROWN Lift Truck branch for shipping instructions for your lift truck.

Lifting a Forklift using a Crane

WARNING

1. Batteries of an electric forklift must be removed before lifting. Lifting an electric forklift without removing the batteries can lead to serious injury to the workers or damage to the equipment by electric shock or leakage of electrolyte.
2. The lifting wire rope and stay must be long enough to avoid contact with the forklift. Short rope/stay can damage the vehicle. If it's too long, it may cause interference.

Cover the rope with rubber or cloth to prevent damage to the vehicle, as necessary.
3. Wire rope and other lifting tools must have sufficient strength, and free of any defect or wear.
4. Avoid impact load to the lifting devices/tools.

1. Check the weight, length, width and height of the vehicle before lifting.
2. Park the crane at an appropriate position.
3. Connect the slings to the points A and B of the figure below.
4. If the sling contacts the vehicle, insert a rubber plate between the sling and the vehicle.
5. Lift up the vehicle slowly.

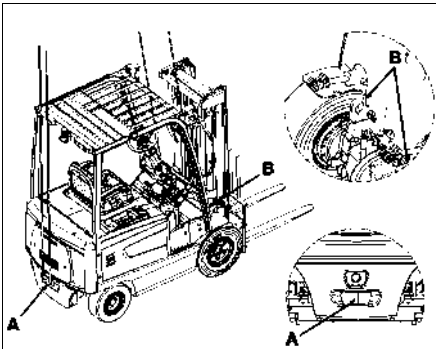

How to Fix Forklift to a Carrier

1. The rope/chain must have sufficient length for fixing.
2. Park the vehicle on a level ground.
3. Set the mast vertically. Lower the fork or attachment to the lowest position.
4. Set all the operating devices to Neutral Position. Turn OFF the start switch.
5. Apply the parking brake. Stop the tyres with blocks (C).
6. Fix the mast top B and rear tow pin A with towing hooks, as shown in the figure below.
7. If the forklift is without mast, fix the rear tow pin A and front cowl D with towing hooks, as shown in the figure below.

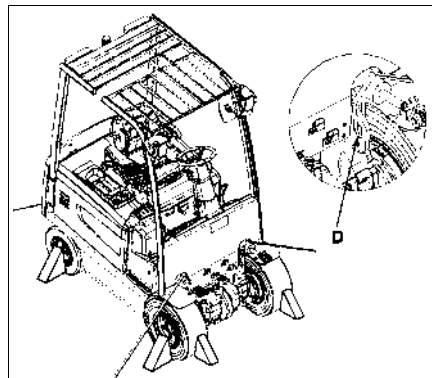
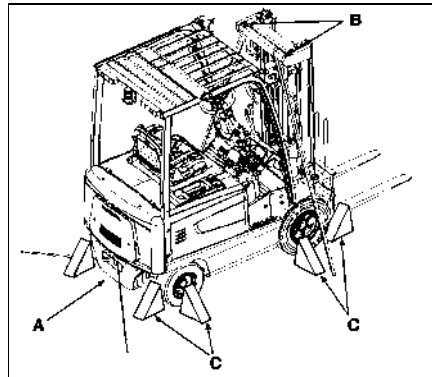

Towing Information

WARNING

Personal injury or death could result when towing a disabled lift truck incorrectly.

Block the lift truck wheels to prevent movement before releasing the brakes. The lift truck can roll free if it is not blocked.

Follow the recommendations below to properly perform the towing procedure.

These towing instructions are for moving a disabled lift truck a short distance, at low speed, no faster than 2 km/h (1.2 mph), to a convenient location for repair. These instructions are for emergencies only.

Always haul the lift truck if long distance moving is required.

Shield must be provided on the towing lift truck to protect the operator if the tow line or bar should break.

Do not allow riders on the lift truck being towed unless the operator can control the steering and/or braking.

Before towing, make sure the tow line or bar is in good condition and has enough strength for the towing situation involved. Use a towing line or bar with a strength of at least 1.5 times the gross weight of the towing lift truck for a disabled lift truck stuck in the mud or when towing on a grade.

Keep the tow line angle to a minimum. Do not exceed a 30° angle from the straight ahead position.

Connect the tow line as low as possible on the lift truck that is being towed.

Quick lift truck movement could overload the tow line or bar and cause it to break. Gradual and smooth lift truck movement will work better.

Normally, the towing lift truck should be as large as the disabled lift truck. Satisfy yourself that the towing lift truck has enough brake capacity, weight and power, to control both lift trucks for the grade and the distance involved.

To provide sufficient control and braking when moving a disabled lift truck downhill, a larger towing lift truck or additional lift trucks connected to the rear could be required. This will prevent uncontrolled rolling.

The different situation requirements cannot be given, as minimal towing lift truck capacity is required on smooth level surfaces to maximum on inclines or poor surface conditions.

Consult your CROWN Lift Truck branch for towing a disabled lift truck.



1. Release the parking brake.

NOTICE

Release the parking brake to prevent excessive wear and damage to the parking brake system.

2. Check that the service brake pedal is released.
3. Key switch is in the OFF position.
4. Disconnect the battery.
5. Fasten the tow bar to the lift truck.
6. Remove the wheel blocks. Tow the lift truck slowly. Do not tow any faster than 2 km/h (1.2 mph).

WARNING

Be sure all necessary repairs and adjustments have been made before a lift truck that has been towed to a service area is put back into operation.

Jacking Information



Jacking up Truck can be dangerous and should be done only by trained personnel using proper tools and procedures.

Block the lift truck wheels to prevent movement while lifting the wheels. The lift truck can roll free if it is not blocked.

Follow the recommendations below, to properly perform the jacking procedure.

NOTICE

Move Trucks to a Secure Non Traffic Maintenance Area with a Level Floor. No Load on Forks.
Remove key from ignition switch.

Hydraulic Jack & Jack Stand Capacity

Hydraulic Jack Capacity

	Model	Height Minimum*	Minimum Requirement	
4 ton class	CB40/45/50X-7, CB50XC-7	180mm	3900Kg	8600lbs

• The height of lift truck with a flat tyre is lower than with an inflated tyre. So Height Minimum of Jack must be less than the value of the above chart.

Stand Capacity should be more than the minimum requirement of Hydraulic Jack Capacity.

Hydraulic Jack & Jack Stand are commercially available and should be especially designed for forklift trucks.

Inspection, Maintenance and Repair of Lift Truck Forks

The following provides practical guidelines for inspection, maintenance and repair of lift truck forks. It also provides general information on the design and application of forks and the common cause of fork failures.

Lift truck forks can be dangerously weakened by repair or modification. They can also be damaged by the cumulative effects of age, abrasion, corrosion, overloading and misuse.

A fork failure during use can cause damage to the equipment and the load. A fork failure can also cause serious injury.

A good fork inspection and maintenance program along with the proper application can be very effective in preventing sudden on the job failures.

Repairs and modifications should be done only by the fork manufacturer or a qualified technician knowledgeable of the material used and the required welding and heat treatment process.

Users should evaluate the economics of returning the forks to the manufacturer for repairs or purchasing new forks. This will vary depending on many factors including the size and type of fork.

Forks should be properly sized to the weight and length of the loads, and to the size of the machine on which they are used. The general practice is to use a fork size such that the combined rated capacity of the number of forks used is equal to or greater than the "Standard(or rated) Capacity" of the lift truck.

The individual load rating, in most cases, will be stamped on the fork in a readily visible area. Generally on the top or side of the fork shank.

- A fork rated at 1500 pounds at 24 inch load centre will be stamped 1500X24.
- A fork rated at 2000 kg at 600 mm load centre will be stamped 2000X600.

The manufacturer identification and year and date of manufacture is also usually shown.

Some countries have standards or regulations which apply specifically to the inspection and repair of forks.

Users may also refer to the International Organization

For Standardization - ISO Technical Report 5057 - Inspection and Repair of Fork Arms and ISO Standard 2330 - Fork Arms-Technical Characteristics and Testing.

Users should be familiar with the requirements for inspection and maintenance of lift trucks as provided by Australian Standard AS2359.

Causes of Fork Failure

Improper Modification or Repair

Fork failure can occur as a result of a field modification involving welding, flame cutting or other similar processes which affect the heat treatment and reduces the strength of the fork.

In most cases, specific processes and techniques are also required to achieve proper welding of the particular alloy steels involved. Critical areas most likely to be affected by improper processing are the heel section, the mounting components and the fork tip.

Bent or Twisted Forks

Forks can be bent out of shape by extreme overloading, glancing blows against walls or other solid objects or using the fork tip as a pry bar.

Bent or twisted forks are much more likely to break and cause damage or injury. They should be removed from service immediately.

Fatigue

Parts which are subjected to repeated or fluctuating loads can fail after a large number of loading cycles even though the maximum stress was below the static strength of the part.

The first sign of a fatigue failure is usually a crack which starts in an area of high stress concentration. This is usually in the heel section or on the fork mounting.

As the crack progresses under repetitive load cycling, the load bearing cross section of the remaining metal is decreased in size until it becomes insufficient to support the load and complete failure occurs.

Fatigue failure is the most common mode of fork failure. It is also one which can be anticipated and prevented by recognizing the conditions which lead up to the failure and by removing the fork service prior to failing.

- Repetitive Overloading

Repetitive cycling of loads which exceeds the fatigue strength of the material can lead to fatigue failure. The overload could be caused by loads in excess of the rated fork capacity and by use of the forks tips as pry bars. Also, by handling loads in a manner which causes the fork tips to spread and the forks to twist laterally about their mountings.

- Wear

Forks are constantly subjected to abrasion as they slide on floors and loads. The thickness of the fork blade is gradually reduced to the point where it may not be capable of handling the load for which it was designed.

- Stress Risers

Scratches, nicks and corrosion are points of high stress concentration where cracks can develop.

These cracks can progress under repetitive loading in a typical mode of fatigue failure.

Overloading

Extreme overloading can cause permanent bending or immediate failure of the forks. Using forks of less capacity than the load or lift truck when lifting loads and using forks in a manner for which they were not designed are some common causes of overloading.

Fork Inspection



Establish a daily and 12 month inspection routine by keeping a record for the forks on each lift truck.

Initial information should include the machine serial number on each the forks are used, the fork manufacturer, type, original section size, original length and capacity. Also list any special characteristics specified in the fork design.

Record the date and results of each inspection, making sure the following information is included.

- Actual wear conditions, such as percent of original blade thickness remaining.
- Any damage, failure or deformation which might impair the use of the truck.
- Note any repairs or maintenance.

An ongoing record of this information will help in identifying proper inspection intervals for each operation, in identifying and solving problem areas and in anticipating time for replacement of the forks.

First Installation

1. Inspect forks to ensure they are the correct size for the truck on which they will be used. Make sure they are the correct length and type for the loads to be handled.

If the forks have been previously used, perform the "12 Month Inspection".

If the forks are rusted, see "Maintenance and Repair".

2. Make sure fork blades are level to each other within acceptable tolerances. See "Forks, Step 4," in the "2000 Service Hours or 1 Year" in "Maintenance Intervals"
3. Make sure positioning lock is in place and working Lock forks in position before using truck. See "Forks, Step 7", in the "2000 Service Hours or 1 Year" in "Maintenance Intervals".

Daily Inspection-Before First Use and at Each Preventive Maintenance Inspection

1. Visually inspect forks for cracks, especially in the heel section, around the mounting brackets, and all weld areas. Inspect for broken or jagged fork tips, bent or twisted blades and shanks.
2. Make sure positioning lock is in place and working. Lock the forks in position before using the truck. See "2000 Service Hours or 1 Year" in "Maintenance Intervals".
3. Remove all defective forks from service.

12 Months Inspection

Forks should be inspected, at a minimum, every 12 months. If the truck is being used in a multi-shift or heavy duty operation, they should be checked every six months. See "Forks" in the Maintenance Section of this manual.

Maintenance and Repair

1. Repair forks only in accordance with the manufacturer's recommendations.

Most repairs or modifications should be done only by the original manufacturer of the forks or an expert knowledgeable of the materials, design, welding and heat treatment process.

2. The following repairs or modifications **SHOULD NOT** be attempted.
 - Flame cutting holes or cutouts in fork blades.
 - Welding on brackets or new mounting hangers.
 - Repairing cracks or other damage by welding.
 - Bending or resetting.

3. The following repairs **MAY** be performed.
 - Forks may be sanded or lightly ground, to remove rust, corrosion or minor defects from the surfaces.
 - Heel sections may be ground with a carbon stone to remove minor surface cracks or defects. Polish the inside radius of the heel section to increase the fatigue life of the fork. Always grind or polish in the direction of the blade and shank length.
 - Repair or replace the positioning locks on hook type forks.
 - Repair or replace most fork retention devices used with other fork types.

4. A fork should be load tested before being returned to service on completion of repairs authorised and done in accordance with the manufacturer's recommendations.

Most manufacturers and standards require the repaired fork to be tested with a load 2.5 times the specified capacity and at the load centre marked on the fork arm.

With the fork restrained in the same manner as its mounting on the lift truck, apply the test load twice, gradually and without shock. Maintain the test for 30 seconds each time.

Check the fork arm before and after the second application of the test load. It shall not show any permanent deformation.

Consult the fork manufacturer for further information as may be applicable to the specific fork involved.

Testing is not required for repairs to the positioning lock or the markings.

Insulation resistance inspection

Insulation resistance should be conducted accordance with following standard at least once a year to ensure operator's safety.

- DIN EN 1175, DIN 43539
- VDE 0117, VDE 0510
- DZ.U. 2003 NR 193 POZ. 1890 art 12

Test values for the battery

Component	Recommended Test Voltage	Measurements		Nominal voltage	Test values
Battery	50VDC	Batt +	Battery	24V	>1200Ω
	100VDC	Batt -	Case	48V	>2400Ω
	100VDC			80V	>4000Ω

Test values for the entire truck

Nominal voltage	Recommended Test voltage	Test values
24V	50VDC	>24KΩ
48V	100VDC	>48KΩ
80V	100VDC	>80KΩ

Torque Specifications

Metric Hardware - This lift truck is almost totally metric design. Specifications are given in metric and U.S. Customary measurement. Metric hardware must be replaced with metric hardware. Check parts books for proper replacement.

NOTE: Use only metric tools on most hardware for proper fit. Other tools could slip and possibly cause injury.

Torque for Standard Hose Clamps-Worm Drive Band Type

NOTICE

The following chart gives the torques for initial installation of hose clamps on new hoses and for reassembly or retightening of hose clamps on existing hose.

Clamp Width	Initial Installation Torque on New Hose	
	N·m ¹	lb·in
16 mm (.625 inch)	7.5±0.5	65±5
13.5 mm (.531 inch)	4.5±0.5	40±5
8 mm (.312 inch)	0.9±0.2	8±2
Clamp Width	Reassembly or Retightening Torque	
	N·m ¹	lb·in
16 mm (.625 inch)	4.5±0.5	40±5
13.5 mm (.531 inch)	3.0±0.5	25±5
8 mm (.312 inch)	0.7±0.2	6±2

¹ Newton meter (N·m) is approximately the same as 0.1 kg·m.

Torque for Standard Bolts, Nuts and Taperlock Studs

NOTICE

The following charts give general torques for bolts, nuts and taperlock studs of SAE Grade 5 or better quality.

Torques for Bolts and Nuts with Standard Threads

Thread Size Inch	Standard Bolt & Nut Torque	
	N·m ¹	lb·in
1/4	12±4	9±3
5/16	25±7	18±5
3/8	45±7	33±5
7/16	70±15	50±11
1/2	100±15	75±11
9/16	150±20	110±15
5/8	200±25	150±18
3/4	360±50	270±37
7/8	570±80	420±60
1	875±100	640±75
1 1/8	1100±150	820±110
1 1/4	1350±175	1000±130
1 3/8	1600±200	1180±150
1 1/2	2000±275	1480±200

¹ Newton meter (N·m) is approximately the same as 0.1 kg·m.

Torques for Taperlock studs

Thread Size Inch	Standard Taperlock Stud Torque	
	N·m ¹	lb·in
1/4	8±3	6±2
5/16	17±5	13±4
3/8	35 ±5	26±4
7/16	45±10	33±7
1/2	65±10	48±7
5/8	110±20	80±15
3/4	170±30	125±22
7/8	260±40	190±30
1	400±60	300±45
1 1/8	500±70	370±50
1 1/4	650±80	480±60
1 3/8	750±90	550±65
1 1/2	870±100	640±75

¹ Newton meter (N·m) is approximately the same as 0.1 kg·m.

Torque for Metric Fasteners

NOTICE

Be very careful never to mix metric with U.S. customary (standard) fasteners. Mismatched or incorrect fasteners will cause lift truck damage or malfunction and may even result in personal injury.

Original fasteners removed from the lift truck should be checked for any damages and kept for reassembly whenever possible. If new fasteners are needed, they must be of the same size and grade as the ones that are being replaced.

The material strength identification is usually shown on the bolt head by numbers.(8.8, 10.9, etc.) The following chart gives standard torques for bolts and nuts with Grade 8.8.

For mounting torques of main parts, Please refer to Service manual for detail.

NOTE: Metric hardware must be replaced with metric hardware. Check parts book for proper replacement.

METRIC ISO2 THREAD		
Thread Size Metric	Standard Torque	
	N·m ¹	lb·in
M6	12±4	9±3
M8	25±7	18±5
M10	55±10	41±7
M12	95±15	70±11
M14	150±20	110±15
M16	220±30	160±22
M20	450±70	330±50
M24	775±100	570±75
M30	1600±200	1180±150
M36	2700±400	2000±300

¹ Newton meter (N·m) is approximately the same as 0.1 kg·m.

²ISO-International Standard Organization.

Lubricant Specifications

Lubricant Information

Some classifications and abbreviations we use in this section follow S.A.E. (Society of automotive Engineers) J754 nomenclature and others follow S.A.E. J183.

All MIL specifications are U.S.A. Military.

Recommended oil viscosities are given in The "Lubricant Viscosities" chart later in this section of the manual.

Greases are classified according to the National Lubricating Grease Institute (NLGI) based on ASTM D217-68 worked Penetration characteristics which give a defined consistency number.

Chain and Linkage Oils (DEO or EO)



Use following engine oils are recommended for use on chains and linkages.

- European oil specification CCMC D3.
- API Specification CD, CD/SF, CE
- Military specifications MIL-L-2104D or E

Hydraulic Oils (HYDO)

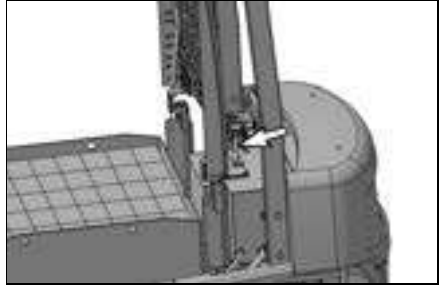

The following commercial classifications can be used in the hydraulic system.

- ISO 6743/4 HM
- AFNOR NFE 48-603 HM
- DIN 51524 TEIL 2 H-LP
- HAGGLUNDS DENISON HFO-HF2
- CINCINNATI P68, 69, 70

Viscosity: ISO VG 32

These oils should have antiwear, antifoam, antirust and antioxidation additives for heavy duty use as stated by the oil supplier. ISO viscosity grade of 32 would normally be selected.

NOTICE

Correct Hydraulic Oil should be used to achieve maximum life and performance from hydraulic system components. The following hydraulic Oil is recommended in most hydraulic and hydrostatic systems.

Make-up oil added to the hydraulic tanks must mix with the oil already in the systems. Use only petroleum products unless the systems are equipped for use with special products.

If the hydraulic oil becomes cloudy, water or air is entering the system. Water or air in the system will cause pump failure. Drain the fluid, retighten all hydraulic suction line clamps, purge and refill the system. Consult your CROWN Lift Truck branch for purging instructions.

Drive Axle Oil

NOTE: Failure to follow the recommendation will cause shortened life due to excessive gear wear.

The API GL- 4 specification or SAE 80W oils could be used.

NOTE: Multi-grade oils are not blended by CROWN for use in transmissions. Multi-grade oils which use high molecular weight polymers as viscosity index improvers lose their viscosity effectiveness by permanent and temporary shear of the viscosity index improver and therefore, are not recommended for transmission and drive train compartments.

Lubricating Grease(MPGA)

Use Multipurpose Molybdenum Grease (MPGM) for all lubrication points. If MPGM grease can not be used, a multipurpose type grease which contains 3% to 5% molybdenum disulfide can be used.

NLGI NO.2 grade is suitable for most temperatures. Use NLGI No.1 or No.0 grade for extremely low temperature.

Brake Fluid



Located on the left side of the cowl.

Use heavy duty hydraulic brake fluid certified by the oil supplier to meet ISO 6743/4 HM VG 10 latest revision.

TOTAL	Azolla ZS 10
AGIP	Acer 10
BP	Engorgol HP 10 HLP 10
CALTEX	Spindurn 10
ELF	Spinelf 10
ESSO	Nuto H 10 Spinesso 10
FINA	Hydran 10
MOBIL	Velocite oil No. 6 Velocite oil E
SHELL	Tilvs oil C10 Morlina 10

Battery Discharge Indicator

The battery discharge indicator should be observed frequently before and during operation.



A fully charged battery will cause a “9 segments” to be displayed on the LCD display. As the battery is discharged, the LCD display will count down, 9, 8, 7, and etc., until “EL” is displayed. When the battery reaches 80% discharge level, the Micro-Controller will cause the LCD display to continuously index through the entire range (1 through 9 segments) to signal that the battery is discharged and lift interrupt is imminent.



EL If the warning is ignored, lift interrupt will prevent the hydraulic pump motor from operating and an “EL” will be displayed on the LCD display.

To prevent over-discharge, the lift interrupt should not be reset by disconnecting and reconnecting the battery.

If the batteries are weak, have them charged or replaced.

The batteries should not be discharged below 80% of the full charge as indicated by their specific gravity.

This specification varies with different battery manufacturers. See the manufacturer’s specifications for specific gravity at 80% discharge. If information is not available from the battery supplier, use 1.140 specific gravity level.

Battery

 **WARNING**

When using pressure air for cleaning purposes, wear a protective face shield and protective clothing. Maximum air pressure must be below 207 kPa (30 psi).

Do not smoke near batteries that are being stored or when checking the electrolyte level.

Electrolyte is an acid solution and can cause personal injury. Avoid contact with skin and eyes.

Maximum life and performance of lift truck batteries is dependent on the operator, battery charging, maintenance and service.

Most dirt and dust picked up by the battery can usually be blown off with low pressure compressed air.

However, if cells are overfilled and electrolyte collects on the covers, the top of the battery will stay wet.

If necessary, clean the top of the battery with a solution of baking soda and hot water.

NOTICE

Vent caps must be tight to prevent soda solution from entering battery cells.

To make the solution, add 0.5 kg (1 lb) of baking soda to 4 liters (1 gallon) of water. Use a brush having flexible bristles. Apply the soda solution to the top of the battery until the cleaning action of the soda stops.

After cleaning action has stopped, rinse batteries thoroughly with water. Dry the batteries with low air pressure.

The lift truck operator must not start his shift with a battery that has been taken off a charger too soon. Batteries are designed to be charged and allowed to cool and stabilise. A battery should never be disconnected from a charger until the charge cycle has been completed.

Low battery operation must be prevented. Operation with a low battery may cause damage to the battery.

Low battery operation will cause higher than normal current in the electrical system. This can damage contactor tips or shorten motor brush life.

Batteries that have been fully charged should have a tag attached for identification.

A battery should be recharged in 8 to 12 hours after being discharged, depending on the charger type, then allowed to cool and stabilise 4 to 8 hours.

Repeated undercharging must be prevented because it can damage the battery.

A battery requires an equalizing charge at least once every 20 normal charge/discharge cycles. This helps correct and prevent unequal cell specific gravity (SG) readings. An "equalizing charge" is a cycle charge with modification, given usually at an interval to bring all cells up to a state of equal charge. An equalizing charge usually adds three to four more hours to the cycle charge, at a low finish rate. It is usually given when the specific gravity (SG) of electrolyte has a variation of more than 20 points (.020) from cell to cell, after a regular cycle charge.

A "cycle charge" will completely recharge the battery. The typical cycle charge for a fully discharged battery usually is an eight-hour charge. The battery must be recharged before it has been discharged over 80% of the rated capacity of the battery. The work shift of the lift truck can be planned so the battery will not be discharged more than 80%.

A battery should never be left in a discharged state because of sulfate formation. This reduces battery life drastically. To extend life always recharge the battery without delay after it has been discharged.

Repeated over discharging of the battery will damage the cells, which will shorten battery life and increase operating cost. Battery life (number of cycles) decreases as the depth of discharge increases. The estimated life of the battery discharged to 80% will be approximately twice as long as if it were discharged 100%.

The battery's maximum temperature is critical. The electrolyte temperature should never exceed 43°C (110°F) either while operating or charging. If higher temperatures are maintained through use or abuse, reduced battery service life can be expected.

Battery condition is important for a long life. The electrolyte level should be maintained at the recommended levels and the battery should be kept clean and dry. "Washing down" batteries at different time periods will reduce the chance of "grounds" caused by electrolyte spills and corrosion. If done often enough, just washing with water alone will eliminate the need for using baking soda. If not, a solution of baking soda and water must be used to wash battery at different time periods.

Add water at regular intervals. Enough water should be added to bring the electrolyte approximately 13.0 mm (.50 inch) above the plates. This is a simple matter with the use of an automatic cell filler, which shows a light when the correct level has been reached. Water should always be added before charging to be sure thorough mixing with acid when gassing occurs near the end of charging period. Use distilled water or have the water supply analyzed.

Charge batteries correctly. It is important that all batteries should be charged according to the manufacturer's instructions. Most of the charging equipment is fully automatic and should be checked periodically. Never operate the lift truck with a fully discharged battery because this will damage the battery.

When a battery charger operates correctly and brings a good battery up to full charge, the current readings will level to the "finish rate." The charging voltage will stabilise, the specific gravity will stop rising and normal gassing can be seen.

NOTICE

• DISPOSAL OF OLD BATTERY

Careless disposal of a battery can harm the environment and can be dangerous to persons.

Always dispose of a battery to an authorised personnel only.

Do not attempt to open or dismantle a battery or a cell.

Cold Storage Applications

When an electric lift truck is operated in cold storage applications, at temperatures as low as -20°C (-4°F), the battery capacity is decreased. Operation at cold temperatures can also cause mechanical failures, short circuits and too much wear due to the formation of ice crystals.

The direct cause of these problems is the extreme changes in temperature in combination with humidity in the air which can result in condensation.

To protect the electric lift truck's components and decrease the effects of the cold temperature, perform the following items before you put the lift truck to work in cold storage applications.

Battery

There is a reduction in battery capacity in cold storage applications. For this reason, it is important to:

- a. Be sure the battery is completely charged at the start of each work cycle.
- b. If possible, keep the lift truck in a warm storage area when it is not in use.
- c. Do not store a discharged battery at below freezing temperature.



Observe the battery discharge indicator frequently

Hydraulic System

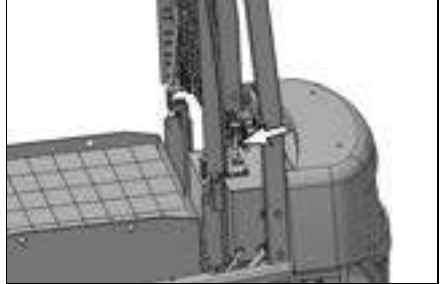

Drain the hydraulic system and fill it with SAE 5 or ISO VG15 hydraulic oil

Lift Chains

1. Remove the chains Clean them in a nonflammable cleaning solvent.
2. Put the chains in molybdenum disulfide (MPGM) grease for one hour. Then, before installation, hang the chains, where they will not move, for three hours.



3. Put MPGM grease on the chains at one-week intervals.
4. Check chains very carefully for wear on the link plate edges, caused when they run over the sheaves. Check the chains regularly for cracked links, loss of shape in the holes, and corrosion.

Lubricant Viscosities and Refill Capacities

Lubricant Viscosities

LUBRICANT VISCOSITIES FOR AMBIENT (OUTSIDE) TEMPERATURES						
Compartment or System	Oil Viscosities		°C		°F	
			Min	Max	Min	Max
Hydraulic and Power Steering System	ISO VG 15		-40	+10	-40	+50
	ISO VG 22		-30	+20	-22	+68
	ISO VG 32		-20	+30	-4	+86
	ISO VG 46		-10	+40	+14	+104
	ISO VG 68		0	+50	+32	+122
*Drive Axle Housing	API GL-4	SAE 80W	-20	+80	-4	+176
*Brake Reservoir	ISO VG 10		-30	+50	-22	+122

* For the detailed information about the lubricant specifications, see "Lubricant Specifications" section.

The SAE grade number indicates the viscosity of oil. A proper SAE grade number should be selected according to ambient temperature.

Refill Capacities

REFILL CAPACITIES-(APPROXIMATE)			
Compartment or System	Liters	U.S. Gal	Imperial Gal
Hydraulic & Power Steering System	55	14.3	12.0
Drive Axle Housing	1.5(Right)	0.4(Right)	0.32(Right)
	1.5(Left)	0.4(Left)	0.32(Left)
Brake Reservoir	0.6	0.16	0.13

Maintenance Intervals

NOTICE

Users should be familiar with the requirements for inspection and maintenance of lift trucks as provided by Australian Standard AS2359.

NOTICE

Never exceed the Maintenance Intervals specified in the manual. Defects and/or damage to the important functional components may be resulted in.

NOTICE

All maintenance and repair, except every 10 service hours or daily, on the lift truck must be performed by qualified and authorised personnel only.

NOTICE

Careless disposal of waste oil can harm the environment and can be dangerous to persons. Always dispose of waste oil to an authorised personnel only.

When Required

Self Diagnostics - Test.....	93
Compact Display Keys.....	94
Run Time Diagnostic.....	95
Carriage Roller Extrusion – Adjust.....	98
Power Modules – Discharge.....	99
Fuses - Replace.....	100
Seat - Lubricate.....	101
Wheel Bolts - Check for Tightness.....	101
Drive Axle Gear Boxes.....	102

Every 10 Service Hours or Daily

Walk - Around Inspection - Inspect.....	103
Mast Channels - Lubricate.....	105
Battery - Check, Exchange, Change.....	105
Indicator - Check.....	107
Tyres and Wheels - Inspect.....	108

First 50 - 100 Service Hours or a week

Drive Axle - Change Oil.....	109
------------------------------	-----

Every 500 Service Hours or 3 Months

Cylinder Rod Extension - Adjust.....	111
Crosshead Rollers - Check.....	111
Mast Carriage, Chains and Attachments - Inspect, Adjust, Lubricate.....	112
Mast Hinge Pins - Lubricate.....	113
Steering - Lubricate.....	113
Steer Angle Switches - Check, Clean.....	113
Overhead Guard - Inspect.....	113
Control Panel - Clean, Inspect.....	114
Directional Lever - Check.....	115
Parking Brake – Test.....	116
Electric Parking Brake – Test (If Equipped).....	116
Hydraulic and Power Steering System - Check.....	117

Every 1000 Service Hours or 6 Months

Drive Axle Oil - Change.....	118
Drive & Pump Motor - Clean, Inspect.....	118
Hydraulic Return Filter - Change.....	119
Parking Brake - Test.....	119
Tyres and Wheels - Inspect, Check.....	120
Lift Chains - Test, Check, Adjust.....	121

Every 2000 Service Hours or Yearly

Hydraulic, Power Steering System.....	123
Steer Wheel Bearings - Reassemble.....	124
Fork - Inspect.....	126

Environment Protection

Environment Protection.....	129
-----------------------------	-----

When Required

You must read and understand the warnings and instructions contained in the Safety section of this manual, before performing any operation or maintenance procedures.

Self Diagnostics - Test

Test Circuits and Components

The Micro-Controller has a built-in diagnostic system to provide aid in rapid troubleshooting of lift truck problems.

NOTE: Make sure the battery is fully charged before any of the following tests are made.

After the self-diagnostics tests have been started, the procedure does not have to be completed. At any point the procedure can be interrupted, and the lift truck made ready for operation.



1. Park the lift truck level, with the forks lowered and the mast tilted forward until the fork tips touch the floor.
2. Block the drive wheels.
3. Release the parking brake.

When directional control lever is equipped

4. Move the directional control lever or the directional control switch to NEUTRAL.
5. Move the key switch to OFF.

Compact Display Keys



As you can see in Fig. on right side of display for type1 or type2 there are four keys: E-S-H, UP (TURTLE), DOWN and ENTER.

The function of each of them is described as follows:

ENTER key

1. When you switch your device on, this key, pressed for 3 consecutive seconds, allows entering both to parameter calibration and to diagnostic mode.
2. During usual operations, this key, pressed for 3 consecutive s, allows you to access merely to diagnostic mode.

Remember that if the display is operating in diagnostic mode during typical operations, you can exit this procedure pressing once ENTER key.

Moreover, ENTER key is used to confirm the new value of the parameter in calibration procedure

UP key

1. Pressing of this key, in calibration and diagnostic mode, you increase the number of the parameter displayed.
2. In calibration phase, you increase the numeric value of the parameter displayed.

TURTLE key

Remember that pressing this key you can toggle between slow running and normal working condition (if the lift truck is already in speed limitation mode).

DOWN key

1. Pressing of this key, in calibration and diagnostic mode, you decrease the number of the parameter displayed.
2. In calibration phase, you decrease the numeric value of the parameter displayed.
3. "3. way of shifting from the visualization of "time meter" and "odometer": you can do it by pressing the "DOWN ARROW" button of Compact display for 1 second in succession during normal working of the display."

E-S-H key

With this key, you can modify the device operating condition, in a circular sequence, as described in Table 7 :

Table 7

CURRENT WORKING CONDITION	WORKING CONDITION AFTER THE KEY PRESSURE
Economic (E)	Standard (S)
Standard (S)	High (H)
High (H)	Limitation 1 (L1))
Limitation 1 (L1)	Limitation 2 (L2)
Limitation 2 (L2)	Limitation 3 (L3)
Limitation 3 (L3)	Economic (E)

NOTE: You can modify system operating modes only after enabling their management with EYE applicative software

Run Time Diagnostic



This operating mode enables you to test main analog and digital signals managed by your system.

Enter diagnostic mode if you are switching on your lift truck:

1. Press ENTER key (for 3 consecutive s) until the symbol "03" lights up.
2. Press DOWN key to enter diagnostic mode; the symbol "d" is visualized and it persists until the first parameter has been selected.

Enter diagnostic mode if you are working as usual with your lift truck:

1. Press ENTER key (for 3 consecutive s) until symbol "d" appears; it will persist as long as the first parameter has been selected.

After diagnostic operation mode has been enabled, you can choose the parameter you want to analyze using UP and DOWN keys (parameter number increases using UP key and decreases with DOWN key)

Here, in Table 11, you have a list of the parameters you can analyze with their respective displaying order : DOWN key).

PARAMETER NUMBER	PARAMETER DESCRIPTION
1	Right traction motor speed [rpm]
2	Right traction motor speed reference [rpm]
3	Left traction motor speed [rpm]
4	Left traction motor speed reference [rpm]
5	Lift voltage [mV]
6	Battery voltage [V·10]
7	Right traction motor power module temperature [°C / °F]
8	Pump motor power module temperature [°C / °F]
9	Pump motor speed [rpm]
10	Pump motor speed reference [rpm]
11	Accelerator potentiometer voltage [mV]
12	Accelerator second potentiometer voltage [mV]
13	Steering sensor voltage [mV]
14	Left traction motor power module temperature [°C / °F]
15	Right traction motor phase current U [A rms]
16	Right traction motor phase current V [A rms]
17	Right traction motor phase current W [A rms]
18	Left traction motor phase current U [A rms]
19	Left traction motor phase current V [A rms]
20	Left traction motor phase current W [A rms]
21	Pump motor phase current U [A rms]
22	Pump motor phase current V [A rms]
23	Pump motor phase current W [A rms]
24	Right traction motor temperature [°C / °F]
25	Left traction motor temperature [°C / °F]
26	Pump motor temperature [°C / °F]
27	Seat switch hour meter [h]
28	Drive motor hour meter [h]
29	Pump motor hour meter [h]
30	Seat switch [digit]
31	Park brake switch [digit]
32	Start switch [digit]
33	Reverse traction direction switch [digit]
34	Forward traction direction switch [digit]

PARAMETER NUMBER	PARAMETER DESCRIPTION
35	Pedal brake switch [digit]
36	3 / 4 wheels selection switch [digit]
37	Auxiliary 1 function (Side shift) switch [digit]
38	Auxiliary 2 function switch [digit]
39	Auxiliary 3 function switch [digit]
40	High lift switch 1 [digit]
41	Tilt switch [digit]
42	High lift switch 2 [digit]
43	Main breaker command [digit]
44	5V out [digit]
45	12V out [digit]
46	24V out [digit]
47	Buzzer command [digit]
48	Fans command [digit]
49	Drive right motor encoder channels
50	Drive left motor encoder channels
51	Drive pump motor encoder channels
52	Lift pressure [bar · 10]
53	Pressure sensor voltage [mV]
54	Weight of the load on the forks [kg]

Table 11: List of accessible parameters in diagnostic mode (from 1th to 54th).

In diagnostic mode selected parameter is visualized as follows:

- In the area dedicated to speed and alarm signals, appears parameter number(flashing)
- Its actual value is displayed in the area reserved to the time meter.

In particular, if the selected parameter is:

Analogue input: COMPACT display shows the parameter value, expressed in the unit of Table 11

Digital input: if the command activated by the operator corresponds to the parameter selected, the value of the quantity is visualized.

Other way the symbol e (error) appears, except in following case: - Seat switch active, for any selected digital input.

To exit diagnostic mode, type ENTER key again.

NOTE: If an alarm occurs when diagnostic mode is enabled, and the system is working as usual, display returns automatically to its typical visualization mode. However you can enter diagnostic mode again, pressing ENTER key (for 3 consecutives), until the last parameter displayed before exiting is visualized.

If the selected parameter is a temperature, also thermal alarm symbol  is visualized.

Carriage Roller Extrusion – Adjust

1. Set the mast vertical.
2. Lower the carriage completely.
3. On full free lift and full free triple lift models, the bottom of the inner mast must be flush with the bottom of the stationary mast.

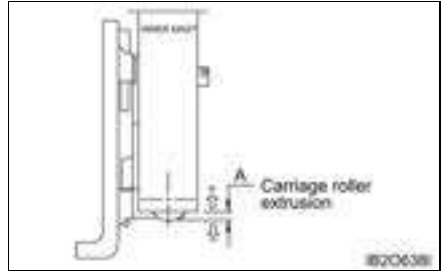

4. Measure the distance from the bottom of the inner upright to the bottom of carriage bearing.
5. The measurement (A) must be as follows in Chart below.

Height of carriage roller extrusion (A)		
STD mast	FF mast	FFT mast
7	-43	-43

Power Modules – Discharge

WARNING

Personal injury could result if power modules have not been discharged properly.

Battery voltage and high amperage are present.

The power modules must be discharged before any contact with the electrical control system is made.

Before touching any electrical components, remove rings, watches and other metallic objects from the hands and arms, then discharge the power modules.



The power modules is located in the control panel at the rear of the lift truck.



1. Disconnect the battery.

2. Open the hood.



3. Before touching any electrical components, the power modules must be discharged. Put a 90 ohm, 30 watt resistor in position between the terminals of the power modules as shown. Hold the resistor in this position for approximately ten seconds. This will discharge the power modules.

4. Perform any necessary maintenance and repair at this time.

5. Close the hood.

6. Connect the battery.

Fuses - Replace

The fuses are located in the control panel and fuse box at the rear of the lift truck.

They protect the electrical system from damage caused by overloaded circuits. Change a fuse if the element separates. If the element of a new fuse separates, have the circuit checked and repaired.

NOTICE

Replace fuses with the same type and size only. Otherwise, electrical damage can result.

If it is necessary to replace fuses frequently, an electrical problem may exist. Contact your CROWN Lift Truck dealer.

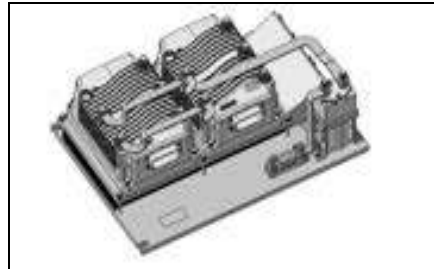
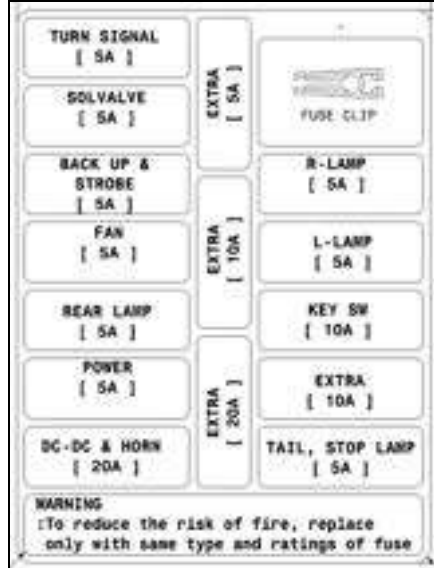

Main Fuse - 500 A

Seat - Lubricate

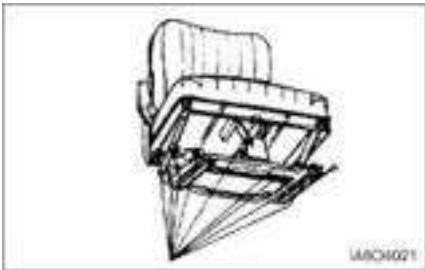

Check the operation of the seat adjusters. Make sure that the seat slides freely on its track. Lightly oil the seat slider tracks.

Wheel Bolts - Check for Tightness

Steer Wheels



Typical example

1. Inspect tightness of wheel nuts in a sequence opposite each other $430 \text{ N}\cdot\text{m}$ (322.5 abaff).

Drive Wheels



Typical example

1. Inspect tightness of wheel nuts in a sequence opposite each other to $600 \pm 75 \text{ N}\cdot\text{m}$ ($450 \text{ lb}\cdot\text{ft}$).

Drive Axle Gear Boxes

NOTE: If there is a leak from drive axle, the oil level should be measured as follows.

Measure Lubricant Level

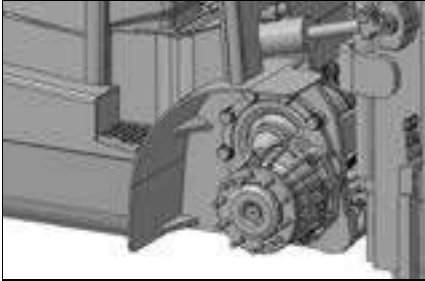

1. Park the lift truck on a level surface. Raise the carriage high enough to gain access to the housing level/fill plugs.
2. Use blocking to secure the carriage in this position.

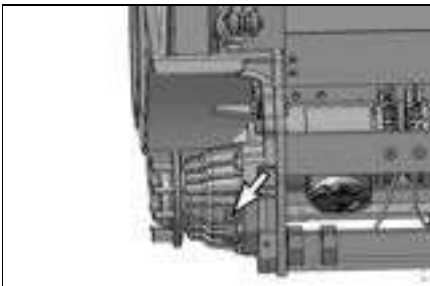

3. Remove the housing level checking plugs. Maintain lubricant level to the bottom of the plug opening. Install the level checking plugs.
4. Remove blocking. Lower the carriage.

Every 10 Service Hours or Daily

You must read and understand the warnings and instructions contained in the Safety section of this manual, before performing any operation or maintenance procedures.

Walk - Around Inspection - Inspect



1. Inspect the operator's compartment for loose items and clean any mud or debris from the floor plates.
2. Inspect the instrument panel for damage to the display.
3. Test the horn and other warning devices for proper operation.



4. Inspect the mast and lift chains for wear, broken links, pins and loose rollers.
5. Inspect the carriage, forks or attachments for wear, damage and loose or missing bolts.



6. Inspect the tyres, valve stems and wheels for cuts, gouges, foreign objects and loose or missing nuts. Refer to "Tyres and Wheels" in "Every 10 Service Hours or Daily" section, if repairs or replacement is necessary.



7. Inspect the overhead guard for damage, loose or missing mounting bolts.



8. Inspect the hydraulic system for leaks, worn hoses or damaged lines.



9. Inspect the drive axle housing and the ground for oil leaks. Refer to “Drive Axle” in “Every 1000 Service Hours or 6 Months” section, if an oil leak is found.



10. Adjust the operator's seat.



11. Adjust the steering wheel to a comfortable position.



When directional control lever is equipped

12. Move the directional lever or the directional control switch to NEUTRAL.



13. Turn the key switch to ON.



Check the LCD display for battery discharge status. A fully charged battery will be displayed on the LCD display.

14. Check the operation of parking brake, service brake, controls and other devices that may be equipped on your lift truck.

15. Check the operation of parking brake, service brake, controls and other devices that may be equipped on your lift truck.

Mast Channels - Lubricate



The channels on the roller-type mast require a break-in period. Apply a light film of lubricant on the channels where the rollers ride. This will prevent metal peel until the rollers set a pattern.

Battery - Check, Exchange, Change

Battery Access

Park the lift truck level, with the forks lowered and the mast tilted forward until the fork tips touch the floor.



1. Disconnect the battery.
2. Tilt the steering column to the full upright position and move the seat fully rearward.
3. Release the hood latch lever which retain the seat and battery cover.



4. Raise the seat and battery cover.

Check Electrolyte

1. Inspect the battery compartment for loose connections, frayed cables and properly secured battery restraint.
2. Clean the top of the battery. If necessary, clean the top of the battery with a solution of baking soda and hot water.

NOTICE

Vent caps must be tight to prevent soda solution from entering battery cells.

A clean battery top is essential to avoid conductive paths on higher voltage batteries.

To make the solution, add 0.5 kg (1 lb) of baking soda to 4 liters (1 gallon) of water. Use a brush having flexible bristles. Apply the soda solution to the top of the battery until the cleaning action of the soda stops.

After cleaning action has stopped, rinse batteries thoroughly with water. Dry the batteries with low air pressure.



3. Check the specific gravity of the battery. If the specific gravity reading is below 1.150, the battery must be charged.

NOTICE

The battery should not be used if a difference in specific gravity between two cells is greater than .020. If this condition exists, the battery should be put on an equalization charge. If this does not correct the condition, consult your battery supplier.

4. Check the electrolyte level of all cells. Maintain the electrolyte level about 13 mm (.50 inch) above the plates. Add water as needed. Use only distilled water. Water is always added after a battery is charged.
5. Lower the seat and battery cover. To closed position and secure with the latch on the front of the cover.
6. Connect the battery.

Battery Exchanging

NOTE: Batteries should be changed, water added and charged only in areas where proper protective and ventilation facilities are provided.

1. Refer to "Battery Access" topic for battery access.
2. Cover the battery with hinged battery cover or with plywood.
3. Install insulated battery tree and hoist, of sufficient capacity, to the battery.
4. Remove the battery. Recharge the battery.
5. Install a fully charged battery.
6. Remove the battery tree. Remove hinged battery cover or plywood from the top of the battery.
7. Connect the battery.
8. Lower the seat and battery cover to closed position and secure with the latch on the front of the cover.
9. Adjust the seat position.

Battery Charging

WARNING

When charging, proper provision must be made for venting of the charging gases. Battery container lids and the covers of battery compartments must be opened or removed. The vent plugs should stay on the cells and remain closed.

With Battery Installed in Lift Truck

1. Refer to "Battery Access" topic for battery access.
2. Connect the battery to the charger and charge the battery. Observe safety warnings for charging batteries.
3. When the battery is fully charged, disconnect the battery from the battery charger.
4. Connect the battery to the lift truck.
5. Lower the seat and battery cover to closed position and secure with the latch on the front of the cover.
6. Adjust the seat position.



Indicator - Check



1. Turn the key switch to ON.



2. Engage the parking brake.

When directional control lever is equipped

3. Move the directional control lever or the directional control switch to the NEUTRAL position.
4. Close the seat switch.



5. Check the indicator LCD display for the discharge state of the battery and the brake oil level.

Tyres and Wheels - Inspect

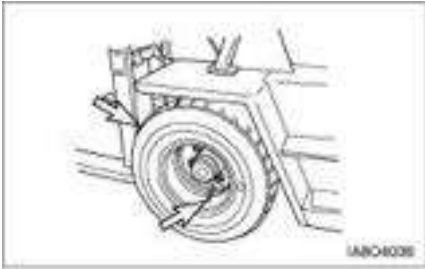

Inspect tyres and valve stems for wear, cuts, gouges and foreign objects.

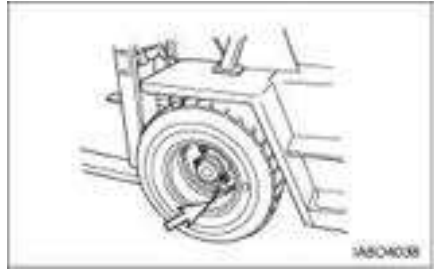

Inflate the tyres, if necessary. See “Tyre Inflation Information” section of this manual.

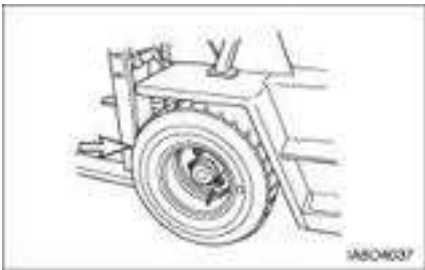

Check all components carefully and replace any cracked, badly worn, damaged and severely rusted or corroded parts with new parts of the same size and type. If there is any doubt, replace with new parts. Do not, under any circumstances, attempt to rework, weld, heat or braze any rim components.

Check Inflation Pressure (If equipped with pneumatic tyres)



Measure the tyre air pressure on each tyre.

First 50 - 100 Service Hours or a week

You must read and understand the warnings and instructions contained in the Safety section of this manual, before performing any operation or maintenance procedures.

Drive Axle - Change Oil

After the first 50-100 hour of operation, subsequently after every 500 hours or 3 months.



Park the lift truck level, with the parking brake engaged and directional control lever in NEUTRAL.

1. Raise the mast and block in place.
2. Turn the key switch to OFF.
3. Unscrew oil air - breather (Oil filling plug) ①, level checking plug ② and remove the drain plug ③. Allow the oil to drain.
4. Clean and install the drain plugs.

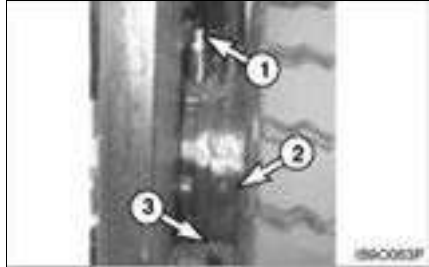

5. Fill the drive axle housing with oil through air - breather plug hole, the accurate amount of oil is defined by the opening of level checking plug.
6. Maintain the oil level.
7. Screw the level checking plug and air breather in with the seal ring.
8. Raise the mast and remove the blocking.

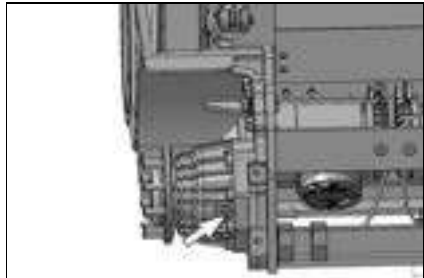

Every 500 Service Hours or 3 Months

You must read and understand the warnings and instructions contained in the Safety section of this manual, before performing any operation or maintenance procedures.

Tilt Cylinders

Lubricate-Pivot Eyebolts



1. Remove floor plates.

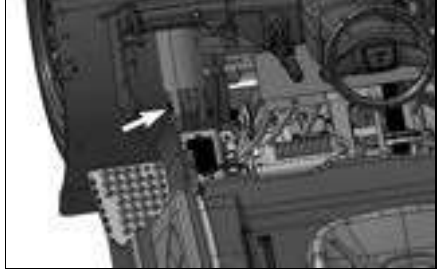

3. Check the pivot eye pins for loose retainer bolts and wear.

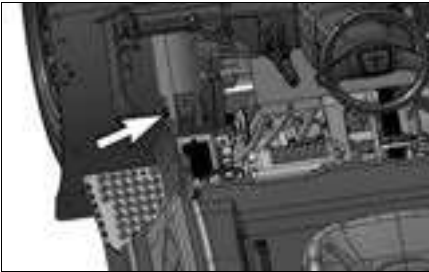

2. Lubricate pivot eyebolts, one fitting on each tilt cylinder.



4. Lubricate the mast pivot eyes, one fitting on each side of the mast.



5. Check the mast pivot eye pins for loose retainer bolts and wear.

Cylinder Rod Extension - Adjust

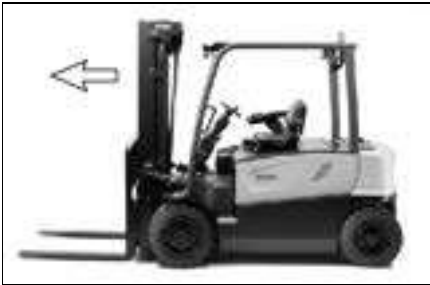

1. Tilt the mast to the full forward position.



2. Measure the extended length of the cylinder rods from the cylinder housing to the pivot eye. The cylinder rods must be within 3.18 mm (.125 inch) of each other.
3. To adjust the cylinder rod extension, loosen bolt.
4. Turn the cylinder rod in or out of pivot eye to obtain the proper adjustment. Turning the rod into pivot eye shortens the stroke. Turning the rod out of pivot eye lengthens the stroke.
5. Tighten bolt to a torque of $95 \pm 15 \text{ N}\cdot\text{m}$ ($70 \pm 10 \text{ lb}\cdot\text{ft}$). Check the cylinder rods again for even travel.
6. With the mast at the tilt back position, install shims as required to permit no gap between pivot eye and spacer, so the mast does not twist at full tilt back position.

Crosshead Rollers - Check

Check Operation

1. Operate the mast through a lift cycle. Watch the chains move over the crosshead rollers. Make sure the chain is tracking over the rollers properly.

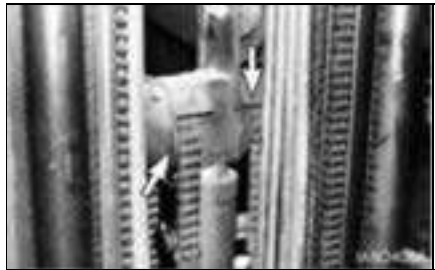

Typical example

2. Check for damaged crosshead rollers, guards and retainer rings.

Mast Carriage, Chains and Attachments - Inspect, Adjust, Lubricate



1. Operate the lift, tilt and attachment controls. Listen for unusual noises. These may indicate a need for repair.



2. Inspect for loose bolts and nuts on the carriage and load backrest. Remove any debris from the carriage and mast.
3. Inspect the forks and attachments for free operation and damage. Have repairs made if needed.



4. Brush in a film of oil on all links of the chain.

5. Raise and lower the carriage a few times to work lubricant into the chain links.

NOTICE

Lubricate chains more frequently than normal where the atmosphere can cause corrosion to components, or when lift truck must work in rapid lift cycles.



6. Inspect the chain anchors and individual links for wear, loose pins or cracked leaves.

NOTE: Have all repairs and adjustments made as required.

Mast Hinge Pins - Lubricate

Lubricate two fittings



1. Lower the forks and tilt the mast forward.

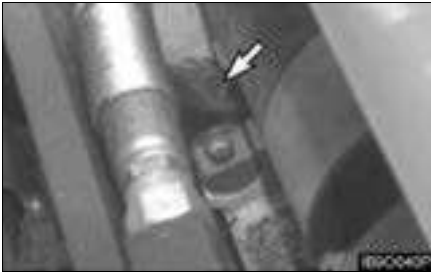

2. Lubricate the mast hinge pins. One fitting on each side of the mast. Total of two fittings.

Lubricate more frequently than normal where the ground minute particles prevent smooth working.

Steering - Lubricate

Lubricate one fitting



Lubricate fitting on steer axle.

Steer Angle Switches - Check, Clean



1. Clean steer angle switches with 205 kpa (30 psi) maximum air pressure until dust is removed.

Check the operation of steer angle switches and the tightness of bracket Adjustment if needed.

Overhead Guard - Inspect



Look for any loose or damaged bolts. Replace damaged bolts or missing bolts with original equipment part only. Retighten bolts to a torque of $90 \pm 10 \text{ N}\cdot\text{m}$ ($67.5 \pm 10 \text{ lb}\cdot\text{ft}$).

Check the overhead guard for bent or cracked sections. Repair if needed.

Control Panel - Clean, Inspect

Park the lift truck level, with the forks lowered, parking brake engaged, directional control lever in NEUTRAL, and the key switch to OFF.

Disconnect the battery.



1. Open the hood.

WARNING

Battery voltage and high amperage are present.

The power modules must be discharged before any contact with the control panel is made.

Personal injury could result if it has not been discharged properly.

2. Discharge the head capacitor. See "power modules" in "When Required" section of this manual.

WARNING

Pressurized air can cause personal injury.

When using pressurized air for cleaning, wear a protective face shield, protective clothing and protective shoes.

The maximum air pressure must be below 205 kPa (30 psi) for cleaning purposes.

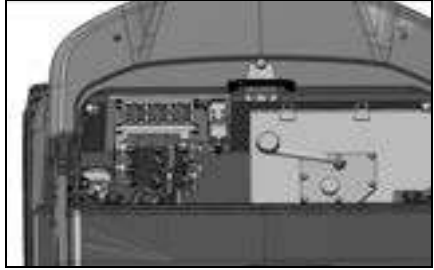

3. Clean the control panel with 205 kPa (30 psi) maximum air pressure, until dust is removed from the control panel.
4. Inspect all wiring for loose connections, frayed cables and loose mounting bolts.
5. Inspect the fuses for looseness, corrosion and broken connections.



6. Close the hood cover and connect the battery.

Directional Lever - Check

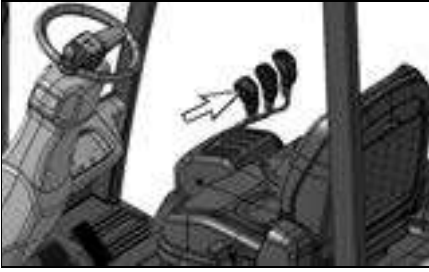

When directional control lever is equipped

Check the tightness of the directional lever mounting bracket. Adjust if needed.

Check for ease of movement of directional lever.

Adjust if needed.

Check for loose wiring. Secure wiring if needed.

Parking Brake – Test

NOTE: Be sure area around the lift truck is clear of personnel and obstructions.

1. Drive the lift truck with a rated load up a 15% incline.

WARNING

To prevent personal injury, the operator must be ready to use the service brake if the parking brake is not adjusted correctly and the lift truck starts to move.

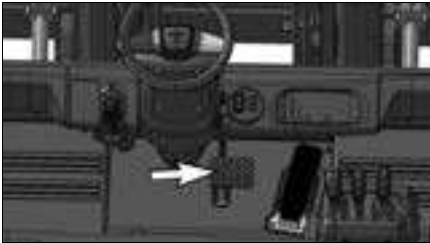

2. Halfway up the incline, stop the lift truck by applying the service brakes.



3. Engage the parking brake.
4. Release the service brake.

If the parking brake has the correct adjustment, the lift truck will be held in place.

NOTE: The lift truck may move slightly while the parking brake is engaging.

5. If the parking brake does not hold, adjust the parking brake lever screw.

Electric Parking Brake – Test (If Equipped)

NOTE: Be sure area around the lift truck is clear of personnel and obstructions.

1. Drive the lift truck with a rated load up a 15% incline.

WARNING

To prevent personal injury, the operator must be ready to use the service brake if the parking brake is not adjusted correctly and the lift truck starts to move.

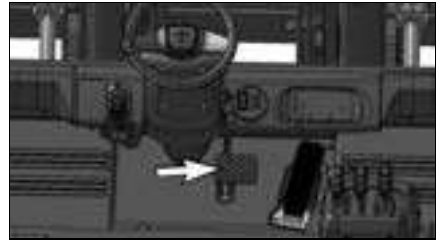

2. Halfway up the incline, stop the lift truck by applying the service brakes.

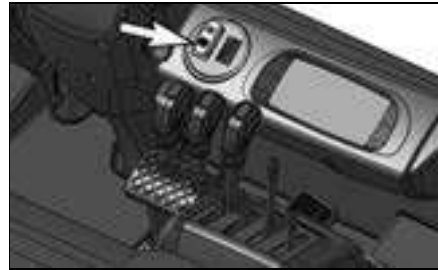

3. Engage the parking brake – Push the parking brake button (1), or when the operator leaves the seat, or there are no operational movements for 10 secs, which will engage the parking brake.
4. Release the service brake.

If the parking brake has the correct adjustment, the lift truck will be held in place.

NOTE: The lift truck may move slightly while the parking brake is engaging.

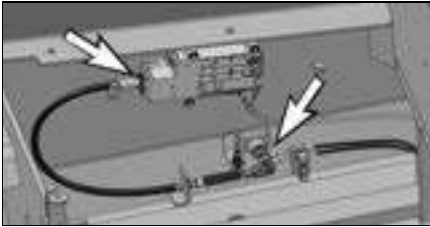

5. If the parking brake does not hold, Electric Parking Brake module and cable which is located left side of main frame should be checked. Please, contact our service team.

Hydraulic and Power Steering System - Check



1. Operate the lift truck for a few minutes to warm the oil.
2. Park the lift truck level, with the forks lowered, mast tilted back (all cylinders retracted), parking brake engaged, directional control lever in NEUTRAL, and the key switch to OFF.
3. Open the hood.
4. Remove the dipstick.
5. Maintain the oil level to the full mark on the dipstick.
6. Install the dipstick.
7. Install the access cover.

Every 1000 Service Hours or 6 Months

You must read and understand the warnings and instructions contained in the Safety section of this manual, before performing any operation or maintenance procedures.

Drive Axle Oil - Change

See topic, "Drive Axle Oil - Change" in "First 50 - 100 Service Hours".

Drive & Pump Motor - Clean, Inspect



5. Slowly lift the front of the lift truck, until the drive wheels are just off the ground.
6. Put stands under the frame. Remove the tension on the lift chains.
7. Remove the battery.
8. Remove the floor plate.

NOTICE

Do not move directional lever from one direction to the other when the drive wheels are off the ground and rotating.

Damage can be caused to the control panel.

1. Disconnect the battery.
2. Block the steer wheels.
3. Remove the battery. See topic, "Battery" in "Every 10 Service Hours or Daily" section of this manual.



4. Fasten lift chains, of equal length, in lift openings in the front of the lift truck.

⚠ WARNING

Battery voltage and high amperage are present.

The power modules must be discharged before any contact with the control panel is made.

Personal injury could result if it has not been discharged properly.

- Blow off the drive motor end shield with 205 kPa (30 psi) maximum air pressure, until dust is removed from the motor.

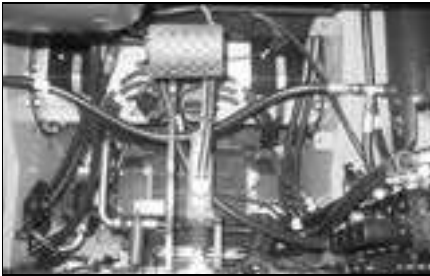

- Install the floor plate.
- Slowly lift the front of the lift truck and remove the stands. Lower the lift truck to the floor. Remove the chains.
- Install and connect the battery. Lower the battery cover and adjust the seat.

Hydraulic Return Filter - Change Parking Brake - Test

⚠ WARNING

Hot oil and components can cause personal injury. Do not allow hot oil or components to contact skin.

Park the lift truck level with the forks lowered, parking brake engaged, directional lever in NEUTRAL and the key switch to OFF.

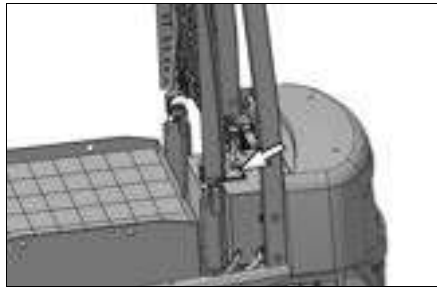

- Loosen the bolts of the hydraulic tank top plate assembly.

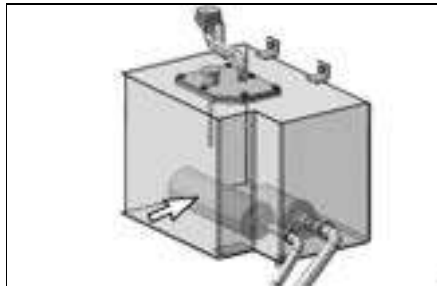

- Remove the return filter by hand and discard it.
- Install a new filter assembly.
- Install the tank top plate assembly and fasten the bolts.

Tyres and Wheels - Inspect, Check

WARNING

Servicing and changing tyres and rims can be dangerous and should be done only by trained personnel using proper tools and procedures. If correct procedures are not followed while servicing tyres and rims, the assemblies could burst with explosive force and cause serious physical injury or death. Follow carefully the specific information provided by your tyre servicing man or dealer.



Do NOT inflate a tyre that has been run while flat or underinflated, without first checking to make sure the locking ring on the wheel is not damaged and is in position.

When tyres are changed be sure to clean all rim parts, and if necessary, repaint to stop detrimental effects of corrosion.

Sand blasting is recommended for removal of rust.

Check all components carefully and replace any cracked, badly worn, damaged and severely rusted or corroded parts with new parts of the same size and type. If there is any doubt, replace with new parts. Do not, under any circumstances, attempt to rework, weld, heat or braze any rim components.



Inspect tyres for wear, cuts, gouges and foreign objects. Look for bent rims and correct seating of locking ring.

If equipped with pneumatic tyres, check tyres for proper inflation. See topic, "Tyre Inflation Pressure."

To inflate tyres always use a clip-on chuck with minimum 60 cm (24 inches) length of hose to an inline valve and gauge.

Always stand behind the tread of the tyre, NOT in front of the rim.

Lift truck capacity is dependent on tyre type. Your lift truck branch should be consulted for possible down ratings when pneumatic tyres are used to replace solid (cushion) tyres.



1. Install drive wheel. Install two nuts opposite each other (180°).
2. Install the remaining nuts. Tighten all nuts in a crisscross sequence opposite each other (180°) to 600 N•m (489 lb•ft).
3. Reverse the lifting procedure for the front of the lift truck and lower it to the ground.

Lift Chains - Test, Check, Adjust

Lift Chain Wear Test

Inspect the part of the chain that is normally operated over the cross head roller. When the chain bends over the roller, the movement of the parts against each other causes wear.

Inspect to be sure that chain link pins do not extend outside of the link hole. If any single link pin is extended beyond its connecting corresponding link, it should be suspected of being broken inside of its link hole. Lift chains are required to check for wear about every 1,000 service hours or 6 months.

Chain wear test is a measurement of wear of the chain links and pins. Take the following steps to check chain wear.

1. Lift the mast and carriage enough for getting tension on lift chains.



Typical example

2. Measure precisely ten links of chain distance at the centre of pins in millimeter.
3. Calculate chain wear rate*.
4. If the chain wear rate is 2% or more, replace the lift chain.

* Chain wear rate (%)

$$= \left(\frac{\text{Actual measurement} - \text{Pitch}^{**} \times 10}{\text{Pitch}^{**} \times 10} \right) \times 100$$

- 1) FOR STO,FF,FFT MAST(2-Light 3.5 ton) for 2~3 ton truck (4000~6500lb)
25.4mm (1 in) for 3.3~Light 3.5 ton truck(7000lb)
- 2) FOR QUAD MAST (for 2.5 ton)
19.05mm (0.75 in) for inner mast chain.
25.4mm (1 in) for carriage and outer mast chain.

**Chain Pitch = 15.88 mm(0.63 in)

Check for Equal Tension



Typical example

Lift the carriage and the mast high enough for getting tension on lift chains. Check the chains, and make sure the tension is the same. Lift chains are required to check for equal tension about every 1,000 service hours or 6 months.

WARNING

Personal injury can be caused by sudden movement of the mast and carriage. Keep hands and feet clear of any parts that can move.

Lift Chain Adjustment



Typical example for carriage equal tension

If the tension is not the same on both chains, take the procedure as follows.

NOTE: If carriage height is not correct, make adjustments by following procedures.

Carriage Chain Adjustment

Make sure that carriage height is correct. If correct, adjust the chain for equal tension. If not, adjust the chain for correct carriage height by adjusting anchor nuts(1),(2).

NOTE: See the previous section, "Carriage Roller Extrusion" in "When Required". for proper height of carriage.

1. Fully lower the carriage and tilt mast forward or lift the carriage and put blocks under the carriage to release the tension from the lift chains.
2. Loosen nut(1) and adjust nut(2) to get proper distance from bottom of inner upright to the bottom of carriage bearing.

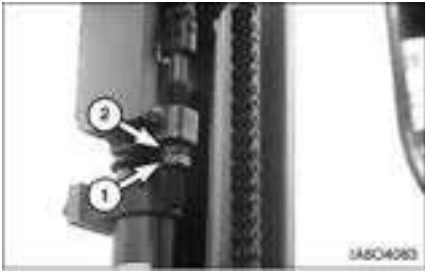

Typical example for carriage chain of STD mast

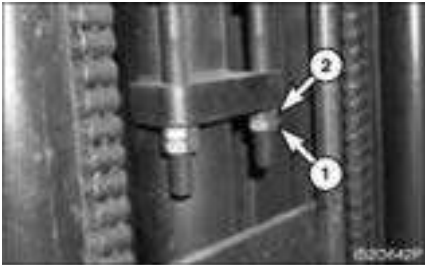

Typical example for carriage chain of FF, FFT, QUAD mast

3. Make adjustment anchor nut(1),(2) for equal chain tension.
4. Set the mast vertical and raise the carriage and check equal chain tension. If not equal, repeat the same procedure as step 1 through step 3.
5. Put LOCTITE No. 242 Tread lock on the threads of the anchor nuts(1),(2) after the adjustment is completed.

Mast Chain Adjustment - FF, FFT Mast



Typical example for FF mast

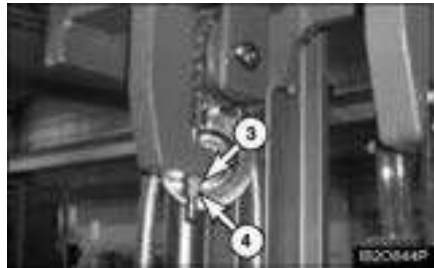

Typical example for FFT mast, QUAD mast

Make sure that mast height is correct. If correct, adjust chain for equal tension. If not, adjust mast chain for correct mast height by adjusting anchor nuts(3),(4).

NOTE: See the previous section, "Carriage Roller Extrusion" in "When Required". for proper inner mast height.

1. Lift the inner mast and put blocks under the inner mast to release the tension from the lift chains.
2. Loosen nut(3) and adjust nut(4) to make inner mast rail flush with outer mast rail bottom.
3. Make adjustment anchor nuts(3),(4) for equal chain tension.
4. Raise the inner mast and check equal chain tension. If not equal, repeat the same procedure as step 1 through step 3.
5. Put LOCTITE No. 242 tread lock on the threads of the anchor nuts(3),(4) after the adjustment is completed.

Every 2000 Service Hours or Yearly

You must read and understand the warnings and instructions contained in the Safety section of this manual, before performing any operation or maintenance procedures.

Hydraulic, Power Steering System

Change Oil and Filter Element



1. Operate the lift truck a few minutes to warm the oil.

Park the lift truck level, with the forks lowered, parking brake engaged, directional lever in NEUTRAL and the key switch to OFF.



2. Remove the hydraulic tank drain plug. Allow the oil to drain. Clean and install the plug.
3. Check stroke of the brake piston. It is necessary to check every 2000 working hours that the stroke of the brake piston is never 3mm. Otherwise it is necessary to replace the brake disk.

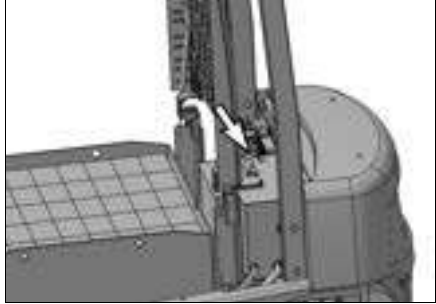

4. Remove the hydraulic filter and discard.



5. Remove the breather / dipstick and the strainer. Wash them in clean, nonflammable solvent and dry them.
6. Install the strainer. Fill the hydraulic tank. See "Refill Capacities." Install the dipstick.
7. Turn the key switch to ON and close the seat switch. Operate the hydraulic controls and steering system through a few cycles, to fill the filter and lines.

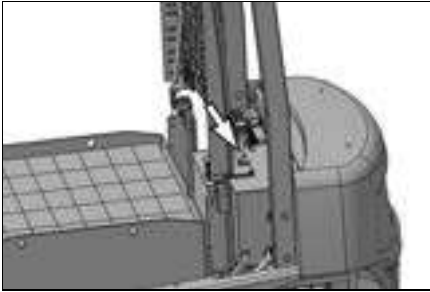

8. Check for oil leaks.
9. Retract all cylinders.
10. Turn the key switch to OFF.
11. Maintain the oil level to the FULL mark on the breather / dipstick. Add oil if necessary.
12. Remove the inner bearing. Clean and lubricate the steering knuckle. Repack both the inner and outer bearing cones.
13. Install the inner bearing. Lubricate the seal and install the wheel assembly on the knuckle.
14. Install the outer wheel bearing and the outer washer. Install the lockwasher and locknut.



15. Tighten the locknut to 200 N·m, while turning wheel hub to seat the bearing.
16. Loosen the locknut. Retorque it to 70 ± 5 N·m. Bend the lockwasher tang to secure locknut.
17. Install the hub cap.
18. Raise the lift truck and remove the blocking. Lower the lift truck to the ground.

Steer Wheel Bearings - Reassemble

Park the lift truck level with the forks lowered, parking brake engaged, and directional control lever in NEUTRAL.



1. Lift the steer wheels off the ground. Place stands or blocking under the frame and steer axle to support the lift truck.
2. Remove the hub cap which is pressed into the wheel hub.



3. Straighten the lockwasher tangs.

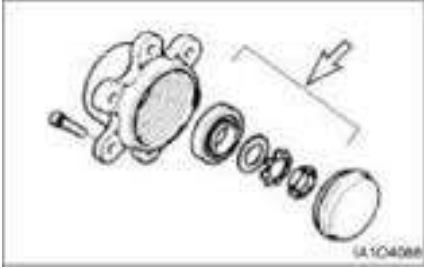

4. Remove the locknut, lockwasher and flat washer. Remove the outer wheel bearing.



7. While rotating the wheel, tighten the locknut to 200 N·m (24 lb·ft). Loosen the nut completely. Tighten the nut again to a torque of 45–55 N·m (8±2 lb·ft) and lock within this range. Install the cover.
8. Raise the lift truck and remove the blocking. Lower the lift truck to the floor.

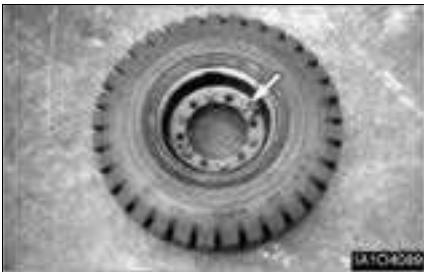

5. Remove the wheel assembly. Examine the wheel for damage and wear. Replace the wheel if necessary.

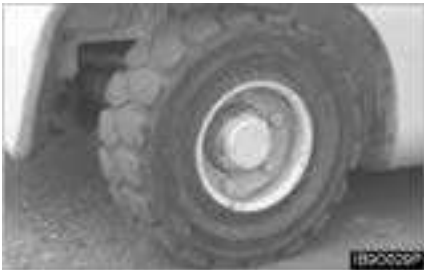

6. Install the steer wheel. Put two nuts opposite each other (180°). Tighten both. Install all remaining nuts. Tighten all nuts in a crisscross sequence opposite each other (180°) to a torque of 140 N·m (105 lb·ft).

Fork - Inspect

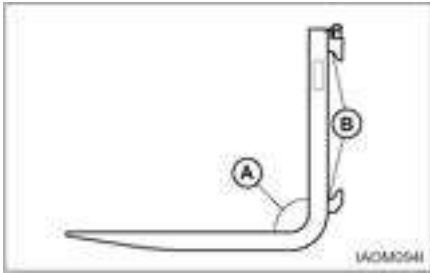

Forks should be inspected, at a minimum, every 12 months. If the truck is being used in a multi-shift or heavy duty operation, they should be checked every six months.

1. Inspect the forks carefully for cracks. Special attention should be given to the heel section (A), all weld areas and mounting brackets (B). Inspect the top and bottom hooks on forks used on hook type carriages and tubes on shaft mounted forks.

Forks with cracks should be removed from service.

"Wet Test" magnetic particle inspection is generally preferred due to its sensitivity and the ease of interpreting the results. Portable equipment is usually recommended so it can be moved to the lift truck.

Inspectors should be trained and qualified in accordance with The American Society for Non Destructive Testing, Level II Qualifications.

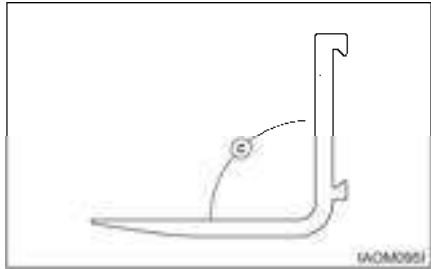

2. Check the angle between the upper face of the blade and the front face of the shank. The fork should be withdrawn from service if angle (C) exceeds 93 degrees or deviates by more than 3 degrees from an original angle other than 90 degrees, as may be found in some special application forks.

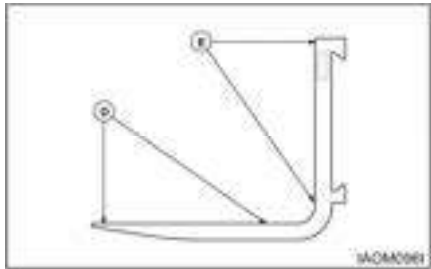

3. Check the straightness of the upper face of blade (D) and the front face of shank (E) with a straight edge.

The fork should be withdrawn from service if the deviation from straightness exceeds 0.5 percent of the length of the blade and/or the height of the shank respectively 5 mm/1000 mm (0.18"/36").

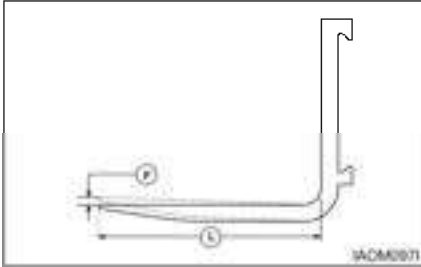

4. Check the difference in height of one fork tip to the other when mounted on the fork carrier. A difference in fork tip height can result in uneven support of the load and cause problems with entering loads.

The maximum recommended difference in fork tip elevation (F) is 6.5 mm (0.25") for pallet forks and 3 mm (0.125") for fully tapered forks. The maximum allowable difference in fork tip elevation between the two or more forks is 3 percent of blade length (L).

Replace one or both forks when the difference in fork tip height exceeds the maximum allowable difference. Contact your local CROWN Lift Truck Branch for further information.

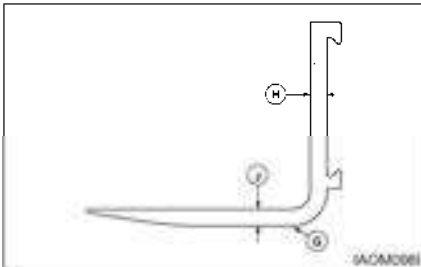

5. Check the fork blade (J) and shank (H) for wear with special attention to the heel (G). The fork should be withdrawn from service if the thickness is reduced to 90 percent or less of the original thickness.

Fork blade length may also be reduced by wear, especially on tapered forks and platens. Remove the forks from service when the blade length is no longer adequate for the intended loads.

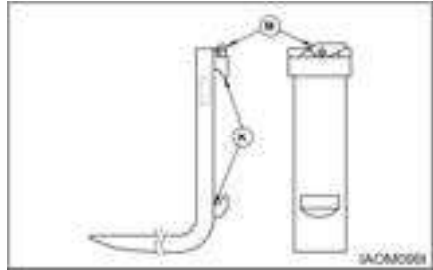

6. Check the fork mountings (K) for wear, crushing and other local deformation, which can cause excessive side to side wobble of the forks. Excessive clearance on hook type forks may allow them to fall from the carrier. Forks which show visible signs of such damage should be removed from service.
7. Check the positioning lock and other fork retention devices to make sure they are in place and working.

Hook type forks use a spring loaded pin (M), located in the top hook, to engage notches in the top carriage bar to hold the fork in place.

When adjusting the fork spacing, the forks are prevented from sliding off the end of the carriage by stop blocks. These stop blocks are at both ends of the carriage and in the path of the bottom fork hook. The load backrest extension may be used in place of the stop blocks in some cases.

Shaft mounted forks may use set collars or spacers on the shaft to either side of the fork. They may also use U bolts, pins, or similar devices which engage the fork through the top structure of the carriage.

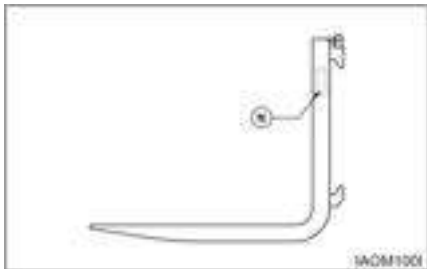

8. Check fork markings (N) for legibility. Renew markings as required to retain legibility.

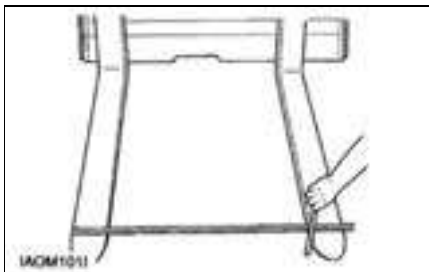

9. a. Lift the mast and operate the tilt control lever, until the top surface of the forks is parallel with the floor. Place two straight bars that are the same width as the carriage, across the forks as shown.
- b. Measure the distance from the bottom of each end of the two bars to the floor. The forks must be parallel within 3 mm (.12 in) for Full Tapered and Polished (FTP) forks, all other forks 6.4 mm (.25 in), for their complete length.
- c. Put one fork, one third from the tip, under a fixture that will not move. Then operate the tilt control with caution until the rear of the truck lifts just off the floor. Follow the same procedure with the second fork. Repeat Step a.

Environment Protection

When servicing this lift truck, use an authorised servicing area and an approved container to collect coolant, oil, fuel, grease, electrolyte and any other potential environmental pollutant before any lines, fittings or related items are disconnected or removed.

After servicing, dispose of those materials in an authorised place and container. When cleaning the lift truck, be sure to use an authorised area.

Index

#

12 Months Inspection81

A

AC..... 9
 Accelerator Pedal50
 Adjustment of Armrest.....64
 After Storage73
 Attachment Abbreviations (includes Special Forks) ..40
 Auto Clamp Control (If Provided)63
 Auto Tilt Control (If Provided)63
 Avoiding Lift Truck Tipover22

B

Batteries..... 14
 Battery - Check, Exchange, Change..... 105
 Battery Access105
 Battery Charging.....107
 Battery Discharge Indicator87
 Battery Disconnect Before Servicing Warning9
 Battery Exchanging106
 Battery Restraint Warning..... 8
 Battery88, 90
 Before Operating the Lift Truck11, 53
 Before Starting the Lift Truck 11
 Before Storage.....73
 Bent or Twisted Forks79
 Better Battery Performance.....55
 Brake Fluid86
 Burn Prevention 14

C

Capacity Chart - With Side Shifter (Hook on) (Not used in Australia).....37
 Capacity Chart (Not used in Australia).....36
 Carriage Roller Extrusion – Adjust.....98
 Causes of Fork Failure.....79
 Centre of Gravity (CG)22
 Chain and Linkage Oils (DEO or EO)85
 Change Oil and Filter Element.....123
 Check Electrolyte.....106
 Check for Equal Tension121
 Check Operation.....111
 Cold Storage Applications90
 Compact Display Keys.....94
 Control Panel - Clean, Inspect114

Crosshead Rollers - Check..... 111
 Cylinder Rod Extension - Adjust..... 111

D

Daily Inspection-Before First Use and at Each Preventive Maintenance Inspection.....80
 Declaration of Conformity.....31
 Directional control forward/reverse switch.....50
 Directional Control Lever (If Equipped)51
 Directional Control Switch62
 Directional Lever - Check 115
 Display Segments.....42
 DOWN key.....94
 Drive & Pump Motor - Clean, Inspect 118
 Drive Axle - Change Oil 109
 Drive Axle Gear Boxes 102
 Drive Axle Oil - Change..... 118
 Drive Axle Oil86
 Drive Wheels 101
 During Storage73

E

E-S-H key.....94
 Electric Parking Brake – Test (If Equipped) 116
 Electric Parking Brake (If Equipped) 48, 70
 Electrical Braking (Plugging).....58
 Emergency Switch (If Equipped).....47
 ENTER key94
 Environment Management.....3
 Environment Protection 129
 Every 10 Service Hours or Daily 103
 Every 1000 Service Hours or 6 Months..... 118
 Every 2000 Service Hours or Yearly..... 123
 Every 500 Service Hours or 3 Months..... 110

F

Falling Objects Protective Structure (FOPS)14
 Fasten the Seat Belt21
 Fatigue.....79
 Film for function of pedals (if equipped).....50
 Finger Tip (Option)60
 Fire Extinguisher.....15
 Fire or Explosion Prevention15
 First 50 - 100 Service Hours or a week 109
 First Installation80
 Fluid Penetration13
 Foreword2
 Fork - Inspect..... 126
 Fork Inspection80
 Forward and Backward Adjustment.....64

Front and Rear Floodlights Switch.....	46
Fuses - Replace.....	100

G

General Hazard Information.....	9
General Warnings to Operator.....	6

H

Hand Placement Warning	7
Hood Opening.....	64
Hook-on type Fork.....	72
Horn Button	46, 63
How to deal with failure of Electric Parking Brake (If equipped).....	71
How to Fix Forklift to a Carrier.....	75
How to Survive in a Tipover (If Operator Restraint System Equipped).....	30
Hydraulic and Power Steering System - Check.....	117
Hydraulic Jack & Jack Stand Capacity	77
Hydraulic Jack Capacity.....	77
Hydraulic Oils (HYDO)	85
Hydraulic Return Filter - Change	119
Hydraulic System.....	90
Hydraulic, Power Steering System.....	123

I

Identification, Lift Capacity and Attachment Plate.....	39
If Optional Suspension Seat Equipped	19
Important Safety Information	4
Improper Modification or Repair.....	79
Inching into Loads.....	65
Index.....	130
Indicator - Check.....	107
Inspection, Maintenance and Repair of Lift Truck Forks	78
Insulation resistance inspection	82

J

Jacking Information	77
---------------------------	----

K

Key Switch.....	41
-----------------	----

L

LED Indicators	45
Lift Chain Adjustment.....	121
Lift Chain Wear Test.....	121
Lift Chains - Test, Check, Adjust	121
Lift Chains	10, 90
Lift Control Lever	51
Lift Fork Adjustment	72
Lift Truck Capacity Rating	39
Lift Truck Controls	48
Lift Truck Operation.....	56
Lift Truck Parking	12
Lift Truck Stability Base	23
Lift Truck Stability	22
Lift Truck Turning	66
Lifting a Forklift using a Crane	75
Lifting Drums or Round Objects	67
Lifting the Load	65
Lines, Tubes and Hoses	16
Literature Information.....	2
Load Backrest Must Be in Place Warning.....	7
Loading or Unloading Trucks/Trailers.....	12
Lubricant Information	85
Lubricant Specifications.....	85
Lubricant Viscosities and Refill Capacities.....	91
Lubricant Viscosities	91
Lubricate one fitting	113
Lubricate two fittings	113
Lubricating Grease(MPGA)	86

M

Machine Lifting and Tiedown Information	74
Maintenance and Repair.....	81
Maintenance Information.....	13
Maintenance Intervals.....	3, 92
Maintenance	3
Mast Abbreviations	40
Mast Carriage, Chains and Attachments - Inspect, Adjust, Lubricate.....	112
Mast Channels - Lubricate	105
Mast Hinge Pins - Lubricate.....	113
Measure Lubricant Level	102
Monitoring Systems Indicator(Compact Display)	42
Mono-Ped Control System (Option).....	59
Mounting and Dismounting.....	11

N

No Alarm, No Movement.....	45
No Riders Warning.....	8
No Standing On Forks Warning, No Standing Under Forks Warning	7

Index Section

Noise at operator ear (measured by PREN 12053) ...35
Noise35

O

Operating Techniques65
Operating the Lift Truck..... 12
Operation Information 11
Operation3
Operator Restraint System (If Equipped).....2, 17
Operator's Station and Monitoring Systems..... 41
Operator's Warning and Identification Plate39
Operator's Warning Plate39
Overhead Guard - Inspect 113
Overhead Guard Must Be In Place Warning.....7
Overloading79

P

Packing Alarm Warning (If Equipped)70
Parking Brake - Test..... 119
Parking Brake – Test..... 116
Parking Brake Forced Release Method (If equipped) 71
Parking Brake Warning..... 8
Parking Brake.....48
Parking the Lift Truck.....69
Power Modules – Discharge99
Pressure Air..... 13

R

Refill Capacities91
Run Time Diagnostic.....95

S

Safety instructions for attachments when transporting
suspended load68
Safety instructions for attachments when transporting
wide loads.....68
Safety Rules.....24
Safety2, 5
Seat - Lubricate..... 101
Seat Adjustment17, 46
Seat Belt 19
Seat Switch Warning..... 9
Seat Switch41
Self Diagnostics - Test93
Serial Number38
Serial Numbers Locations38
Service Brake Pedal.....49

Shipping74
Sideshift Attachment Control (If Equipped)52
Specifications.....32
Stability and Centre of Gravity22
Starting the Lift Truck.....11
Steer Angle Switches - Check, Clean..... 113
Steer Wheel Bearings - Reassemble 124
Steer Wheels 101
Steering - Lubricate 113
Steering Knob (If Equipped).....59
Storage Information73

T

Table of Contents 1
Test Circuits and Components93
Test values for the battery82
Test values for the entire truck82
Tilt Control Lever52
Tilt Cylinders 110
Tilt Steering Column46
Torque for Metric Fasteners84
Torque for Standard Bolts, Nuts and Taperlock Studs
.....83
Torque for Standard Hose Clamps-Worm Drive Band
Type.....83
Torque Specifications83
Torques for Bolts and Nuts with Standard Threads ...83
Torques for Taperlock studs84
Towing Information76
Training Required to Operate or Service Warning.....5
Transportation Hints74
Traveling With or Without a load66
TURTLE key94
Tyre Information16
Tyres and Wheels - Inspect 108
Tyres and Wheels - Inspect, Check..... 120

U

Unloading Lift Truck67
Up and Down Adjustment64
UP key94

W

Walk - Around Inspection - Inspect 103
Walk - Around Inspection53
Warning Signs and Labels 5, 17
Wheel Bolts - Check for Tightness 101
When Required93